

The background of the cover is a photograph of a long, narrow trench dug into the earth. Inside the trench, a black pre-insulated pipe is laid out. The pipe has a distinct corrugated section. The trench is surrounded by lush green trees and foliage, suggesting a rural or wooded setting. In the bottom left corner, there is a circular inset showing a cross-section of the pipe. This cross-section reveals a central pipe with a blue interior, surrounded by a red insulation layer, and an outer black protective jacket.

Uponor

Pre-Insulated Piping Systems Installation and Technical Guide

APRIL 2014

from
heat source...
...to building

Pre-Insulated Pipe Systems

Connecting you to renewable heat

No special tools, no welding and no fuss Quality product, long lifetime

Uponor Pre-Insulated Pipes - the only choice for economical transport of hot and cold fluids for both domestic and commercial applications.

Besides excellent insulating efficiency, our light weight pre-insulated pipes offer flexibility, ease of installation and a service life in excess of 25 years.

Applications:

- Remote boilers
- Biomass
- CHP
- District heating
- District cooling

Suitable for:

- Heating water
- Hot tap water
- Cooling water
- Industrial fluids

Solutions for:

- Family homes
- Social housing
- Farm buildings
- Smallholdings
- Outbuildings

The Advantages:

- **Easy to handle**, light weight and highly flexible
- **Easy to assemble**, no special tools required
- **Rapid work progress**, up to 200m joint free installation
- **Cut to length service**, delivered directly to site
- **Full design service**, pipe sizing and material take-offs
- **Load bearing**, up to 60 tonnes at 0.5m depth

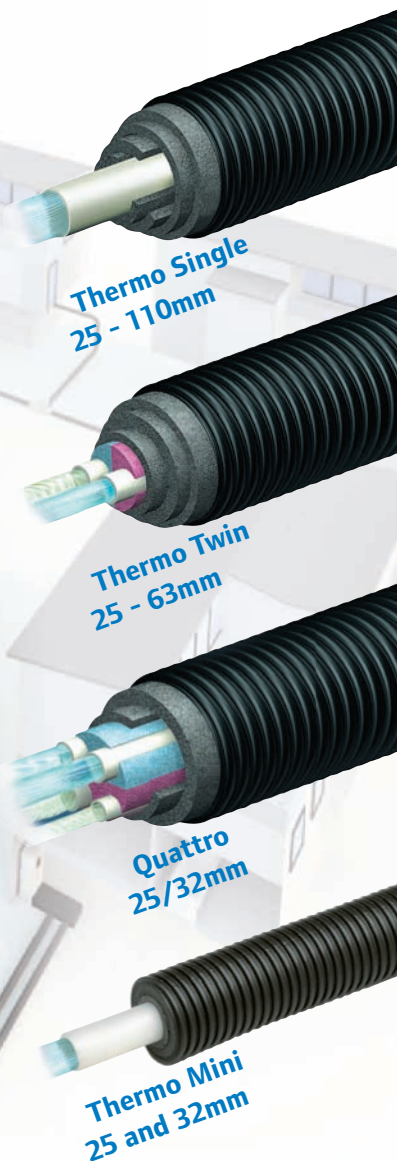

Over 30 million metres installed worldwide!

Contents:

SYSTEM DESCRIPTION AND FIELDS OF USE	4	EXAMPLES OF INSTALLATION	28
System Description	4		
Product Construction	6	NOTES ON PROCESSING AND INSTALLATION	29
Fields of Use	7	Pipe Handling	30
PRODUCT PROFILE	8	MOUNTING INSTRUCTIONS	33
Uponor Thermo	8	Wipex Fittings	33
Uponor Aqua	10	Rubber End Caps	34
Uponor Quattro	12	Insulation Kits	34
Uponor Supra/Supra Plus	13	Chamber	37
		Feed-through Kits	38
		PWP Wall Seal	39
JOINTING SYSTEMS	15	PRESSURE TESTING	40
Wipex Fittings	15		
Insulation Kits	16	TECHNICAL SPECIFICATIONS	42
Rubber End Caps	17		
Wall Seals	18	APPENDIX	45
Chamber	19	Weight/volume tables	45
		Long-term Properties	45
DIMENSIONING PIPES	20	Heat Loss Charts	46
Thermo	20	Pipe and Fittings Selector Tool	50
Aqua	24	Delivery Programme	51
Supra	25		
PLANNING	26		
Design Basics	26		
Planning the Route	27		

System Description and Fields of Use

System description



From practice - for practice. This is the fundamental idea behind our flexible, pre-insulated piping systems. The flexibility of the material, the convenient connecting methods and the well-attested service life and robustness of our pre-insulated pipes ultimately ensure that you, as the expert, can complete your projects quickly, economically and reliably.

Just the same, whether you are dealing with an extensive supply network or a single connection to one building. Hot water, drinking water, cooling and waste water are transported as reliably as many other liquid media in industrial applications. The service we provide in association with our pre-insulated pipe systems also offers you comprehensive support at every phase of your project.



Quality, signed and sealed

Uncompromising quality is our number-one policy. Fully comprehensive quality control in production is just one aspect of our quality management system. And we regularly make sure that independent inspection organisations certify that our products meet the strictest standards.



Kiwa KOMO approval and certification

The interplay between components (Thermo Single, Thermo Twin, rubber end caps, Wipex fitting range and insulation sets) is examined in the twice-yearly system approval according to the current BRL 5609 guideline. The approval



certifies a system service life of at least 30 years, as well as absence of leaks at a water pressure of 0.3 bar and an ambient temperature of 30°C. In addition, the heat losses, static strength and creep behaviour of the pipes are checked according to consistent specifications.

DIN Certco certification

The annual certification according to VDI 2055 verifies the heat loss figures. The heat loss graphs for the flexible, pre-insulated pipes are prepared on this basis. The certification is based on defined layout conditions, and that means that the values are a good reflection of real life.

Static strength certification

The certificate, based on ATV DVWK-A127, demonstrates that our pipes, when laid in accordance with defined conditions, are suitable for loading by heavy traffic (SWL 60 = 60 t) according to worksheet ATV-A 127. The ring stiffness of the jacket pipe is proven according to EN ISO 9969.

Unchanging minimal thermal conductivity of the insulation

Material tests according to EN 15632 at 80°C demonstrate that our insulation material absorbs less than 1 % water by volume. This low water absorption means that the insulating properties are practically unchanged.

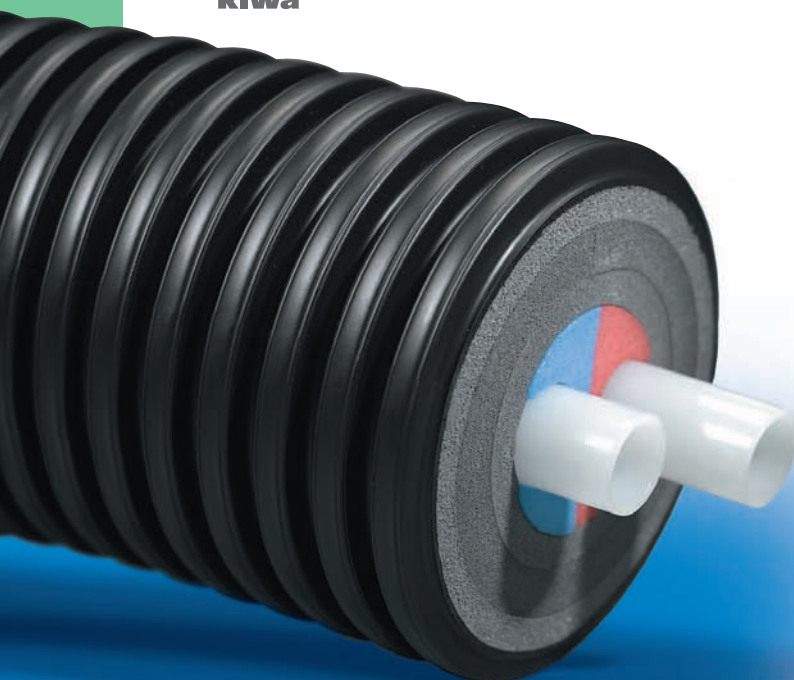

Supplied to the right dimensions and laid directly from the roll.

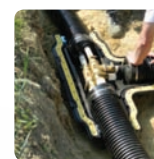

Connect easily, permanently and practically.



Flexibly and quickly through the brickwork to the main distribution point.

Flexibility - from the beginning through to the house lead-in

No welding, no special tools. The flexibility and the low weight of our pre-insulated pipes mean that they are easy to handle and that building work proceeds fast. They are also supported by a comprehensive range of accessories. From a variety of wall lead-throughs, insulation kits and the proven range of fittings.

The most important advantages for laying and connecting

- Problem-free laying around corners and obstacles
- Up to 200 meters of joint-free installation in one piece
- Self-adjusting tube structure make it unnecessary to fit expansion compensators.
- Fast building progress / short assembly times
- Easy, reliable jointing method, including subsequent insulation of connections and branches



- Cutting service: shorter lengths, individually trimmed for your building site
- Both standard and partial lengths are delivered in shortest time.
- Comprehensive support from experienced engineers for planning and layout
- Project support and product training on-site



Easy handling thanks to extraordinary flexibility: it is not just when rolling out in a ditch, but particularly at house lead-ins that our customers appreciate these advantages of the product.

Product Construction

The high quality of the flexible, pre-insulated pipes from Uponor is a consequence of the strengths of the individual elements. The

combination of stable yet flexible jacket pipes, ageing-resistant, cross-linked polyethylene insulating layers and robust, long-life media

pipes creates system pipes that can be laid easily and quickly and that function reliably.

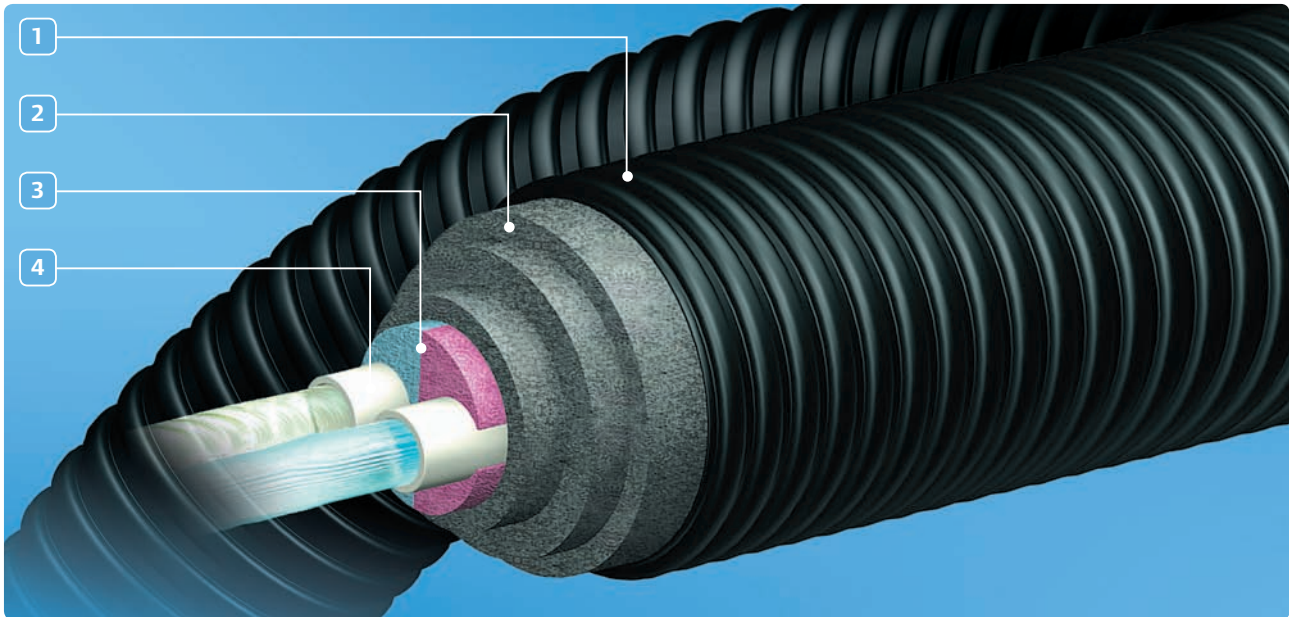

- 1 The PE-HD jacket pipe: impact-resistant, long-life yet flexible due to the Uponor pipe geometry
- 2 The insulation made from cross-linked polyethylene foam: ideal insulating properties, ageing-resistant, resistance to moisture and very high flexibility
- 3 The coloured centring profile effectively avoids confusion between the flow and return pipes
- 4 The PE-Xa medium pipe: temperature-resistant, and resistant to incrustation and stress cracking



The most important properties at a glance

- Easy handling and fast building progress through exceptional flexibility
- Age-resistant, permanently elastic insulation of closed-cell cross-linked polyethylene foam, water absorption < 1% by volume
- Heat losses ¹⁾ externally monitored by DIN Certco
- Medium pipe resistant to corrosion and incrustation
- The medium pipe made of crosslinked polyethylene (PE-Xa) offers exceptional resistance to stress cracking, aggressive media, frost and micro-organisms
- Optimum ring stiffness, resistant to impact and pressure at the same time as offering high flexibility when laying and low specific weight of all the materials

¹⁾ Uponor Thermo, see Appendix

Fields of Use

An overview of key product information

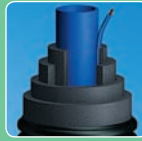
	Medium temperature	Operating pressure	 Uponor Thermo	 Uponor Aqua	 Uponor Quattro	 Uponor Supra
Application						
Potable water, cold	20 °C	16 bar				●
Potable water, warm	95 °C	10 bar		●	●	●
Heating water	95 °C	6 bar	●		●	
Cooling water	-10 °C	16 bar				●
Chemicals			on request	on request		on request
Foodstuffs				on request		on request
Pressurized waste water			on request			on request
Variations						
Anti-freeze cable*						●
Heating tape*			●	●		
Material						
Medium pipe			PE-Xa with EVOH	PE-Xa	PE-Xa and PE-Xa with EVOH	PE-100
Insulating material			PE-X	PE-X	PE-X	PE-X
Jacket pipe			PE-HD	PE-HD	PE-HD	PE-HD

*optional

Product Profile

Uponor Thermo

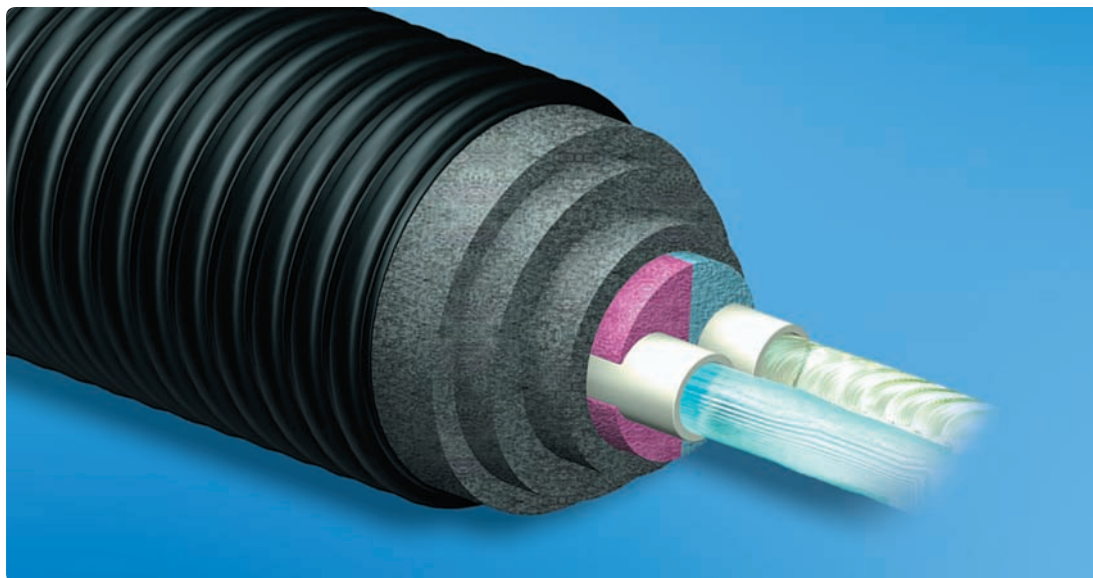

Practical, perfect and multi-functional for heating water supply systems

The ideal solution for the distribution of heating water in local heat supply networks or as tie-ins to building complexes and individual housing. The Uponor Thermo Twin variant combines flow and return in just one pipe system.



6 V 046
6 V 047

Uponor Thermo Mini



95 °C



6 bar



25–32 mm

Main application

- Heating water

Other applications

- Waste water
- Chemicals

Medium pipe

- PE-Xa with EVOH, SDR 11

Insulating material

- PE-X foam

Material jacket pipe

- HDPE

Note:

For small-scale applications in the private sector (e.g. in a greenhouse) Especially suitable for installation in empty conduits.

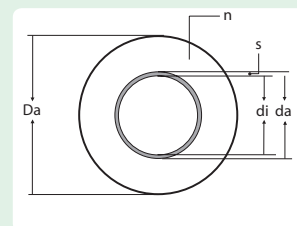

Old Code	Order Code	Medium pipe da / di / s [mm]	n	Jacket pipe Da [mm]	Weight [kg/m]	Delivery lengths [m]	Bending radius [m]	Insulation thickness [mm]
500052	1018132	25 / 20.4 / 2.3	1	68	0.50	200	0.20	15
500053	1018133	32 / 26.2 / 2.9	1	68	0.55	200	0.25	12

Uponor Thermo Single



95 °C



6 bar



25–110 mm

Main application

- Heating water

Other applications

- Waste water
- Chemicals

Medium pipe

- PE-Xa with EVOH, SDR 11

Option

- Heating cable

Insulating material

- PE-X foam

Material jacket pipe

- HDPE

Note:

The tried-and-tested solution for heating water distribution in local heating networks and for individual building tie-ins.

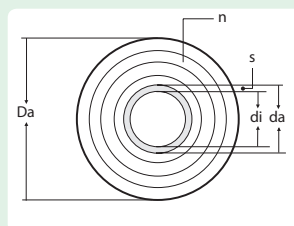

Old Code	Order Code	Medium pipe da / di / s [mm]	n	Jacket pipe Da [mm]	Weight [kg/m]	Delivery lengths [m]	Bending radius [m]	Insulation thickness [mm]
500002	1018109	25 / 20.4 / 2.3	4	140	1.10	200	0.25	45
500003	1018110	32 / 26.2 / 2.9	3	140	1.20	200	0.30	42
500004	1018111	40 / 32.6 / 3.7	4	175	2.20	200	0.35	55
500005	1018112	50 / 40.8 / 4.6	4	175	2.43	200	0.45	50
500006	1018113	63 / 51.4 / 5.8	3	175	2.73	200	0.55	43
500007	1018114	75 / 61.4 / 6.8	3	200	3.74	100	0.80	49
500008	1018115	90 / 73.6 / 8.2	3	200	4.20	100	1.10	39
500009	1018116	110 / 90.0 / 10.0	3	200	5.24	100	1.20	30

Uponor Thermo Twin



95 °C



6 bar



25–63 mm

Main application

- Heating water

Other applications

- Waste water
- Chemicals

Medium pipe

- PE-Xa with EVOH, SDR 11

Insulating material

- PE-X foam

Material jacket pipe

- HDPE

Note:

Combined flow and return in one pipe system incl. dog bone to prevent confusion when the pipes are being connected.

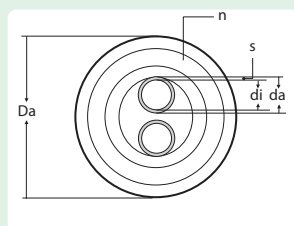

Old Code	Order Code	Medium pipe da / di / s [mm]	n	Jacket pipe Da [mm]	Weight [kg/m]	Delivery lengths [m]	Bending radius [m]	Insulation thickness [mm]
500102	1018134	(2x) 25 / 20.4 / 2.3	3	175	2.09	200	0.5	43
500103	1018135	(2x) 32 / 26.2 / 2.9	3	175	2.16	200	0.6	38
500104	1018136	(2x) 40 / 32.6 / 3.7	2	175	2.50	200	0.8	28
500105	1018137	(2x) 50 / 40.8 / 4.6	3	200	3.59	100	1.0	32
500106	1018138	(2x) 63 / 51.4 / 5.8	2	200	4.49	100	1.2	18

Uponor Aqua

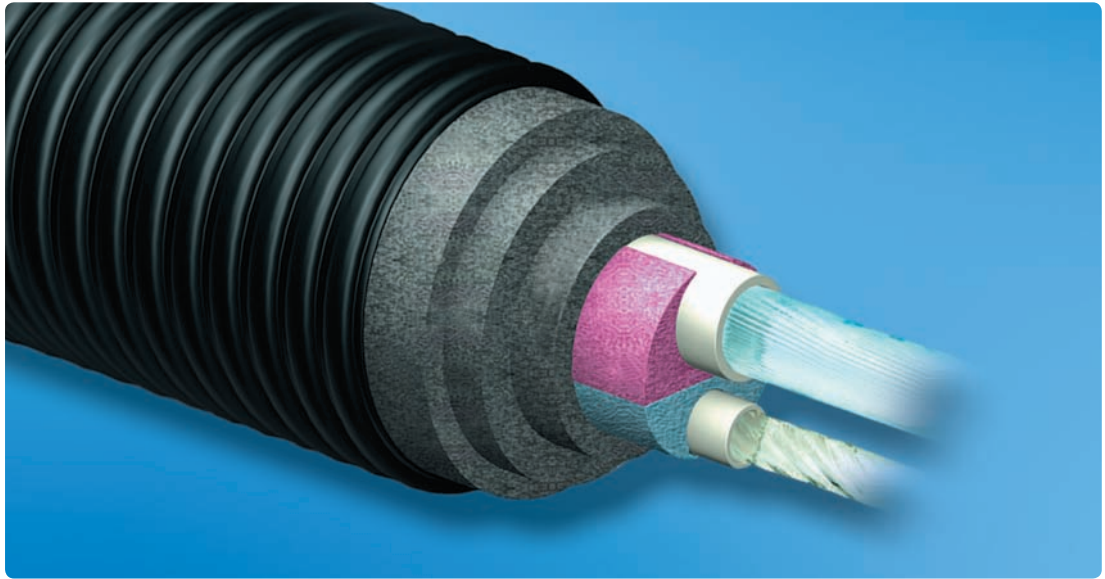

Your flexible specialist for warm potable water

Simply unbeatable for quick, safe and cost-efficient installations in the warm water supply sector. The twin design is supplied with a solution using integrated circulation lines.



Uponor Aqua Single



95 °C



10 bar



25–63 mm

Main application

- Potable water, warm

Other applications

- Foodstuffs
- Chemicals

Medium pipe

- PE-Xa, SDR 7.4

Option

- Heating cable

Insulating material

- PE-X foam

Material jacket pipe

- HDPE

Note:

The safe and cost-effective pipeline for warm water installations.

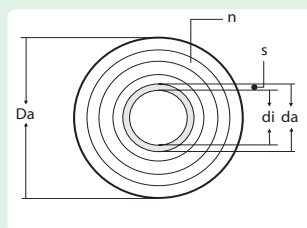

Old Code	Order Code	Medium pipe da / di / s [mm]	n	Jacket pipe Da [mm]	Weight [kg/m]	Delivery lengths [m]	Bending radius [m]	Insulation thickness [mm]
500020	1018117	25 / 18.0 / 3.5	3	140	1.20	200	0.35	45
500021	1018118	32 / 23.2 / 4.4	3	140	1.30	200	0.40	42
500022	1018119	40 / 29.0 / 5.5	4	175	2.37	200	0.45	55
500023	1018120	50 / 36.2 / 6.9	4	175	2.71	200	0.55	50
500024	1018121	63 / 45.6 / 8.7	3	175	3.17	200	0.65	43
-	1018122	75 / 54.4 / 10.3	3	200	4.3	100	0.9	49
-	1018123	90 / 65.4 / 12.3	3	200	5.3	100	1.2	39
-	1036036	110 / 79.8 / 15.1	3	200	6.5	100	1.3	30

Uponor Aqua Twin



95 °C



10 bar



25–50 mm

Main application

- Potable water, warm with circulation

Other applications

- Foodstuffs
- Chemicals

Medium pipe

- PE-Xa, SDR 7.4

Insulating material

- PE-X foam

Material jacket pipe

- HDPE

Note:

Including circulation line. The two-coloured Dog Bone prevents confusion when connecting the medium pipe.

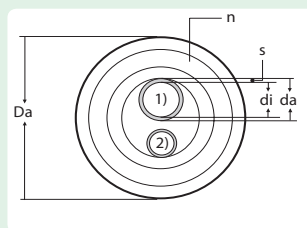

Old Code	Order Code	Medium pipe da / di / s [mm]	n	Jacket pipe Da [mm]	Weight [kg/m]	Delivery lengths [m]	Bending radius [m]	Insulation thickness [mm]
500113	1018139	1) 25 / 18.0 / 3.5 2) 25 / 18.0 / 3.5	3	175	2.22	200	0.65	43
500114	1018140	1) 32 / 23.2 / 4.4 2) 25 / 18.0 / 3.5	3	175	2.37	200	0.70	38
500116	1018141	1) 40 / 29.0 / 5.5 2) 25 / 18.0 / 3.5	3	175	2.62	200	0.90	38
500118	1018142	1) 50 / 36.2 / 6.9 2) 25 / 18.0 / 3.5	2	175	2.90	200	1.00	28

Uponor Quattro

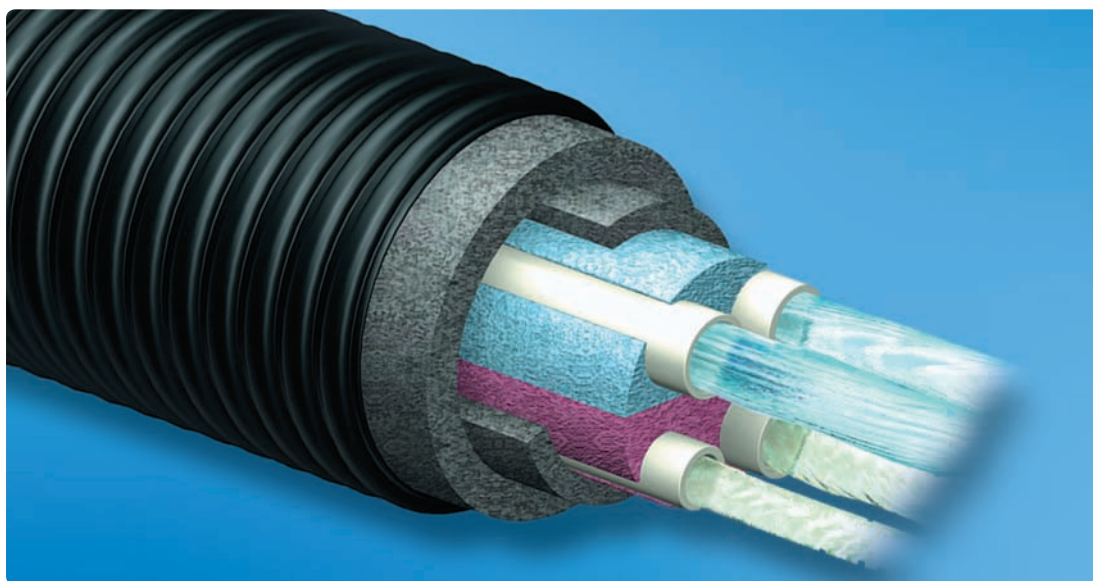

Just the thing for individual building tie-ins

“One for all!” heating water, flow and return, potable water plus circulation – all in just one pipe: there is no easier nor more cost-efficient way of safely linking up individual buildings or building complexes.

Uponor Quattro

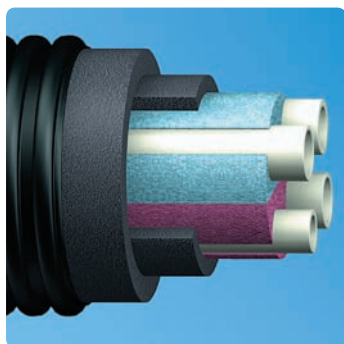

95 °C



6 /10 bar



25–32 mm

Main application

- Heating water
- Potable water, warm with circulation

Medium pipe

- PE-Xa, SDR 7.4
- PE-Xa with EVOH, SDR 11

Insulating material

- PE-X foam

Material jacket pipe

- HDPE

Note:

Uponor Quattro pipelines are also particularly practical and cost-efficient for linking up annex buildings. The two-coloured Dog Bone prevents confusion when connecting the medium pipe.

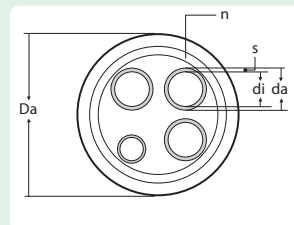

Product Code	Order Codes	Medium pipe $d_a / d_i / s$ [mm]	n	Jacket pipe D_a [mm]	Weight [kg/m]	Delivery lengths [m]	Bending radius [m]	Insulation thickness [mm]
500311	1018147	2x 25 / 20.4 / 2.3 2x 25 / 18.0 / 3.5	3	175	2.40	200	0.80	35
500331	1018148	2x 32 / 26.2 / 2.9 2x 25 / 18.0 / 3.5	2	175	2.60	200	0.80	35
500351	1018149	2x 32 / 26.2 / 2.9 32 / 23.2 / 4.4 25 / 18.0 / 3.5	2	175	2.70	200	0.80	34

Uponor Supra/Supra Plus



The ultimate for cold potable water and cooling water networks

Refreshingly consistent for cold liquid media. Besides cold potable water applications, the preferred fields of use for Uponor Supra are cooling water networks in hotel complexes or industrial facilities.

Supra Plus



For liquids and water transport at extremely low temperatures, Uponor Supra Plus is supplied with a self-regulating freeze protection cable. It makes good sense to use this product if the pipeline is installed in conditions lacking weather protection, i.e. above ground or in shallow burial situations. The cable, rated at 10 w/m will prevent freezing down to -20°C .

Note:

When ordering Supra Plus, an additional 0.5m allowance should be made at each end to facilitate easier cable connection. Burial depth should also be considered to ensure sufficient pipe length is ordered.

Uponor Supra

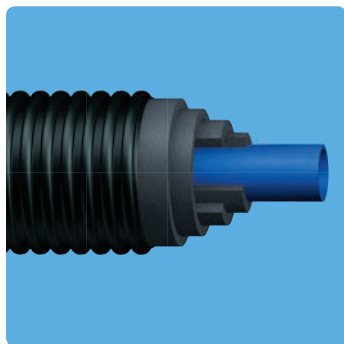

20 °C



16 bar



25–110 mm

Main application

- Potable water, cold
- Cooling water

Other applications

- Waste water

Medium pipe

- HDPE (PE 100), SDR 11

Option

- Frost cable (Supra Plus)

Insulating material

- PE-X foam

Material jacket pipe

- HDPE

Note:

For swimming pools, hotels, wellness centres or in industry. Supra is optimized for media temperatures from – 10 °C to + 20 °C.

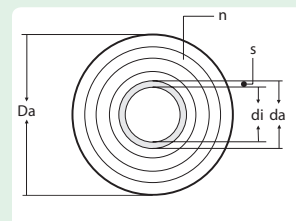

Old Code	Order Code	Medium pipe da / di / s [mm]	n	Jacket pipe Da [mm]	Weight [kg/m]	Delivery lengths [m]	Bending radius [m]	Insulation thickness [mm]
500042	1018124	25 / 20.4 / 2.3	1	68	0.52	200	0.20	15
500043	1018125	32 / 26.2 / 2.9	1	68	0.62	200	0.25	12
500044	1018126	40 / 32.6 / 3.7	3	140	1.44	200	0.30	39
500045	1018127	50 / 40.8 / 4.6	3	140	1.67	200	0.40	34
500046	1018128	63 / 51.4 / 5.8	2	140	1.97	200	0.50	27
500047	1018129	75 / 61.4 / 6.8	3	175	2.89	100	0.60	38
500048	1018130	90 / 73.6 / 8.2	2	175	3.31	100	0.70	28
500049	1018131	110 / 90.0 / 10.0	3	200	5.24	100	1.20	30

Uponor Supra Plus

Old Code	Order Code	Medium pipe da / di / s [mm]	n	Jacket pipe Da [mm]	Weight [kg/m]	Delivery lengths [m]	Bending radius [m]	Insulation thickness [mm]
-	1048902	25 / 20.4 / 2.3	1	68	0.52	150	0.20	15
-	1048903	32 / 26.2 / 2.9	1	68	0.62	150	0.25	12
-	1048904	40 / 32.6 / 3.7	3	140	1.44	150	0.30	39
-	1048905	50 / 40.8 / 4.6	3	140	1.67	150	0.40	34
-	1048906	63 / 51.4 / 5.8	2	140	1.97	150	0.50	27
-	1048907	75 / 61.4 / 6.8	3	175	2.89	100	0.60	38
-	1048908	90 / 73.6 / 8.2	2	175	3.31	100	0.70	28
-	1048909	110 / 90.0 / 10.0	3	200	5.24	100	1.20	30

Jointing Systems

Wipex fittings

Uponor Wipex jointing technology – for our Thermo, Aqua and Quattro products

The Wipex Coupling is specifically designed for connecting cross-linked polyethylene pipes, produced by Uponor, for hot and cold water in domestic and district heating installations. The coupling is available for pipe dimensions 25-110 mm, in two series marked PN 6 for Thermo pipes and PN 10 for Aqua pipes.

The Wipex Coupling is designed to give an excellent tight grip. The gripping strength is higher than the tensile strength of the pipe, and the sealing performance is unaffected by temperature fluctuations.

Wipex Couplings are robust and simple in design, can be fitted very easily and quickly even in difficult locations and confined spaces. The ring spanners used when fitting the coupling are very small and convenient to use in relation to the size of the coupling.

- The Wipex Coupling is patented, tested according to DVGW (Germany), NKB (Sweden), CSTB (France), KIWA (Holland) and approved.



- The main components of the fittings are made of DR brass (resistant to dezincification).
- O-rings are used to make a seal between the couplings and pipe fittings.
- Additional sealing using teflon or hemp is not required
- The Wipex fitting system allows for an extremely wide range of connection combinations.
- Only tools needed are two fixed wrenches plus a pair of pliers.



Design recommendation:

When connecting from the Uponor Wipex system to third-party components, the terminating Uponor Wipex element must consist of a fitting (bend or socket) with an internal thread.

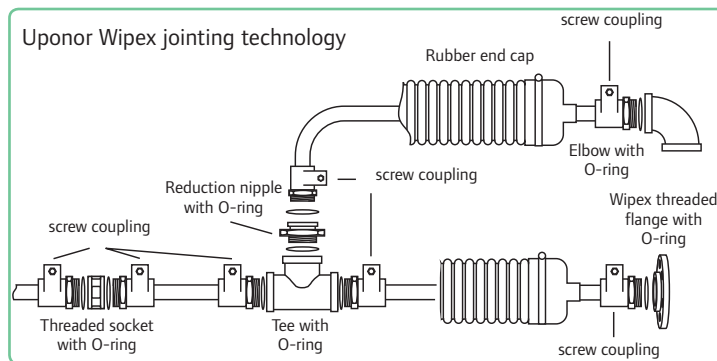

Note: For guidance on correct choice of fitting, refer to Appendix, 'Pipe and Fittings Selector Tool'.

Uponor insulation sets

Suitable insulation sets are available for insulating and sealing the 140, 175 and 200 mm jacket pipes on all straight, elbow and T-joints. They fit single and twin

pipes equally well. An H-insulation set is also available for the conversion from single main pipes to twin branch pipes. The insulation sets consist of insulated

half-shells, which are jointed using bolts and sealant. Jacket pipe diameter 68 mm can be fitted to the insulation sets using Uponor reducing rings.



Uponor T insulation set



Uponor elbow insulation set



Uponor straight insulation set



Uponor H insulation set



Uponor reducer rings



Note:
Please use the Uponor chamber for Quattro connections

Note:
Joints should not be located underneath roads because this makes later access difficult. H insulation sets are not resistant to heavy vehicles.

If an H insulation set must be installed underneath the road, a concrete slab can be used above the joint to distribute the heavy traffic load.

Rubber end caps

To protect the pipe ends and for component partitioning

Uponor rubber end caps protect the insulation at cut pipe ends and provide partitions between components. It is important to provide this protection against moisture ingress or damage, so

that the whole system can fulfil its purpose optimally over many years. A gasket ring is also supplied to prevent the entry of water. The end caps can be assembled by easily and

conveniently pulling them over the ends of the pipes, after which they are fully secured with a jubilee clip.



Note:

Before the rubber end caps are fitted, the insulation must be removed from the pipe back to the proper length. The dimensions of the insulating kit must be observed here.

Note:

The jubilee clip must not be mounted when Uponor H insulation sets are being used!

Note:

The Uponor rubber end caps must be fitted to the ends of the jacket pipes before making a connection to a medium pipe!



Single



Twin



Quattro

Wall Seals

Uponor feed-through kit (non-pressure-waterproof)

This wall sleeve can be used for the feed-through in building foundations wherever there is no pressurized water. Feed-through sleeve is mounted in

place when the foundations are cast or is bricked in a hole drilled afterwards. The shrink sleeve prevents water from leaking into the

foundations from in between the pipe and the feedthrough sleeve. The kit contains a 400 mm long feed-through sleeve and a wide shrink sleeve.

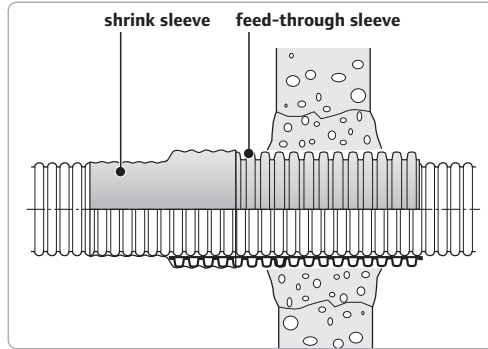
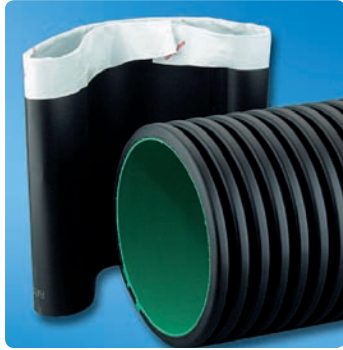

Uponor PWP wall seal (pressure-waterproof)

Uponor PWP wall seal

An Uponor PWP wall seal must be used wherever water at pressure is to be expected. They can either be used directly in a coated tapping drill hole into waterproof concrete, or in a fibre cement pipe that is concreted or bricked into place.

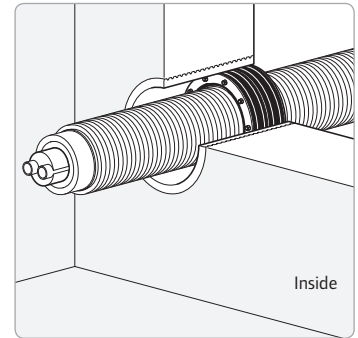
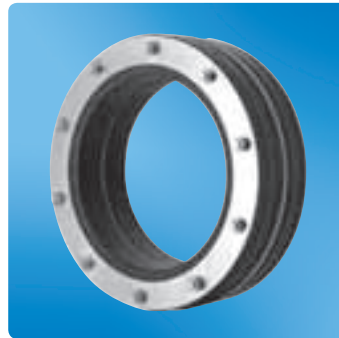

Uponor supplementary kit

If it is not possible to introduce the jacket pipe perpendicularly into the wall duct, we recommend that the Uponor supplementary kit is used to disperse any possible stresses.

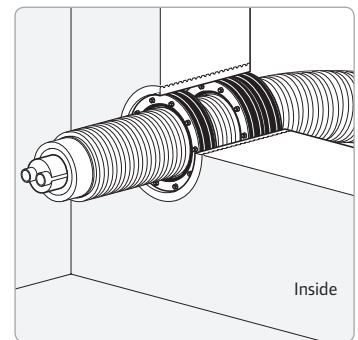
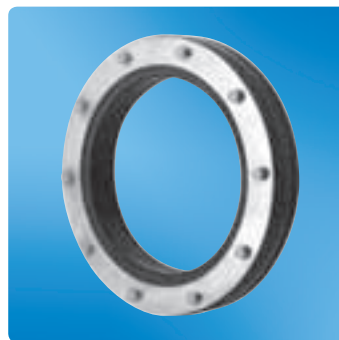

Chamber

Uponor connecting chambers are designed for pipe joints that cannot be made with an Uponor insulation kit. This includes, for instance, connections between Uponor Single to two or more twin

pipes, or for the Uponor Quattro pipes. The rotationally moulded chamber has walls made of polyethylene and, on the inside, it is coated with a PE insulant. The branching chamber enables

the joining of other connections at a later date. The chamber has a watertight structure and is suitable for all pipe dimensions (casing pipe size 140-200 mm).

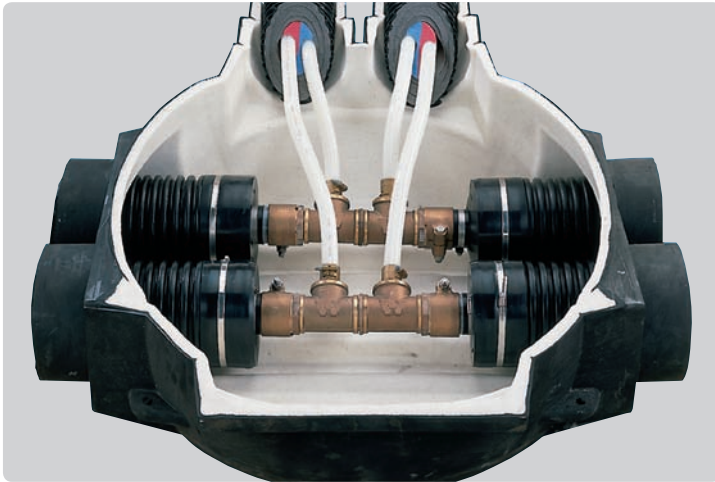

Note:

Joints should not be located underneath roads because this makes later access difficult and heavy vehicles could damage the joint.

If joints underneath roads are unavoidable a concrete slab can be used above the joint to distribute the heavy traffic load.



The rotomolded chambers are made of polyethylene and the insulative layer on the inside ensures minimized heat losses.

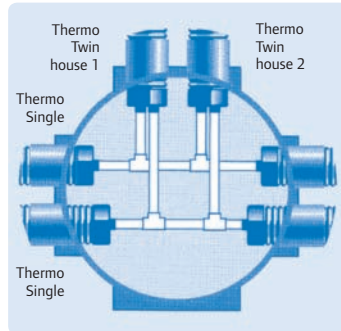

Heating supply from the main line to 2 houses

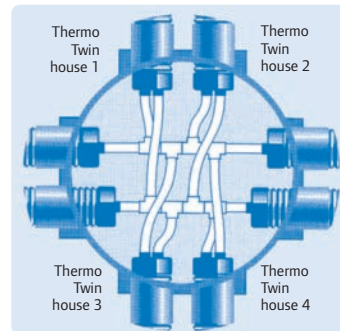

Heating supply from the main line to 4 houses

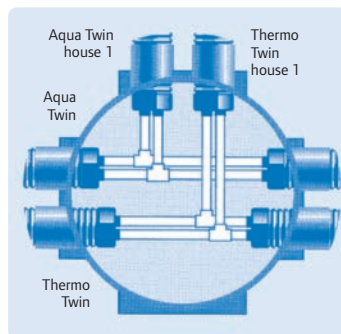

Heating and tap water from the main lines to the house

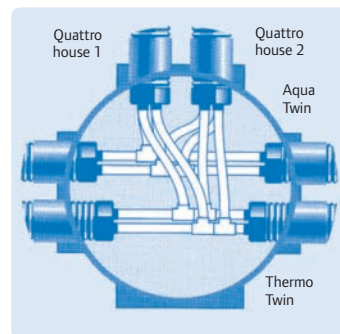

Heating and tap water from the main line to 2 houses using Quattro

Dimensioning Pipes

Thermo

The following table enables approximation of pipe size for a given heat load (kW) and design temperature drop (ΔT). Generally, pipe dimensions are selected according to the available pressure.

Heating pipe: rapid design

Spread							Mass flow	Pipe type		Pipe type	
$\Delta T=10K$	$\Delta T=15K$	$\Delta T=20K$	$\Delta T=25K$	$\Delta T=30K$	$\Delta T=35K$	$\Delta T=40K$		$\Delta p.v$	$\Delta p.v$	$\Delta p.v$	$\Delta p.v$
10 kW	15 kW	20 kW	25 kW	30 kW	35 kW	40 kW	860 kg/h	25/20.4 0.30974 kPa/m 0.74962 m/s	32/26.2 0.09786 kPa/m 0.46148 m/s		
20 kW	30 kW	40 kW	50 kW	60 kW	70 kW	80 kW	1720 kg/h	32/26.2 0.32917 kPa/m 0.92296 m/s	40/32.6 0.11240 kPa/m 0.58708 m/s	50/40.8 0.03872 kPa/m 0.37481 m/s	
30 kW	45 kW	60 kW	75 kW	90 kW	105 kW	120 kW	2580 kg/h	32/26.2 0.66923 kPa/m 1.38445 m/s	40/32.6 0.22851 kPa/m 0.88062 m/s	50/40.8 0.02805 kPa/m 0.56221 m/s	
40 kW	60 kW	80 kW	100 kW	120 kW	140 kW	160 kW	3440 kg/h	40/32.6 0.37806 kPa/m 1.17416 m/s	50/40.8 0.13023 kPa/m 0.74962 m/s	63/51.4 0.04348 kPa/m 0.47232 m/s	
50 kW	75 kW	100 kW	125 kW	150 kW	175 kW	200 kW	4300 kg/h	50/40.8 0.19244 kPa/m 0.93702 m/s	63/51.4 0.06425 kPa/m 0.59040 m/s	75/61.2 0.05053 kPa/m 0.41646 m/s	
60 kW	90 kW	120 kW	150 kW	180 kW	210 kW	240 kW	5160 kg/h	50/40.8 0.26445 kPa/m 1.12443 m/s	63/51.4 0.08839 kPa/m 0.70848 m/s	75/61.2 0.03859 kPa/m 0.49975 m/s	
70 kW	105 kW	140 kW	175 kW	210 kW	245 kW	280 kW	6020 kg/h	50/40.8 0.34945 kPa/m 1.31183 m/s	63/51.4 0.11513 kPa/m 0.82656 m/s	75/61.2 0.05053 kPa/m 0.58304 m/s	
80 kW	120 kW	160 kW	200 kW	240 kW	280 kW	320 kW	6880 kg/h	63/51.4 0.14654 kPa/m 0.94464 m/s	75/61.2 0.06334 kPa/m 0.66633 m/s	90/73.6 0.02657 kPa/m 0.46072 m/s	
90 kW	135 kW	180 kW	225 kW	270 kW	315 kW	360 kW	7740 kg/h	63/51.4 0.18133 kPa/m 1.06272 m/s	75/61.2 0.07836 kPa/m 0.74962 m/s	90/73.6 0.05053 kPa/m 0.51831 m/s	
100 kW	150 kW	200 kW	250 kW	300 kW	350 kW	400 kW	8600 kg/h	63/51.4 0.21940 kPa/m 1.18080 m/s	75/61.2 0.09480 kPa/m 0.83291 m/s	90/73.6 0.03905 kPa/m 0.57590 m/s	
110 kW	165 kW	220 kW	275 kW	330 kW	385 kW	440 kW	9460 kg/h	63/51.4 0.26071 kPa/m 1.29888 m/s	75/61.2 0.11263 kPa/m 0.91620 m/s	90/73.6 0.04639 kPa/m 0.63349 m/s	
120 kW	180 kW	240 kW	300 kW	360 kW	420 kW	480 kW	10320 kg/h	75/61.2 0.13183 kPa/m 0.99949 m/s	90/73.6 0.05429 kPa/m 0.69108 m/s	110/90.0 0.02064 kPa/m 0.46217 m/s	
130 kW	195 kW	260 kW	325 kW	390 kW	455 kW	520 kW	11180 kg/h	75/61.2 0.15238 kPa/m 1.08278 m/s	90/73.6 0.06274 kPa/m 0.74867 m/s	110/90.0 0.02385 kPa/m 0.50068 m/s	
140 kW	210 kW	280 kW	350 kW	420 kW	490 kW	560 kW	12040 kg/h	75/61.2 0.17427 kPa/m 1.16608 m/s	90/73.6 0.07174 kPa/m 0.80626 m/s	110/90.0 0.02727 kPa/m 0.53919 m/s	
150 kW	225 kW	300 kW	375 kW	450 kW	525 kW	600 kW	12900 kg/h	75/61.2 0.19746 kPa/m 1.24937 m/s	90/73.6 0.08129 kPa/m 0.86385 m/s	110/90.0 0.03089 kPa/m 0.57771 m/s	
160 kW	240 kW	320 kW	400 kW	480 kW	560 kW	640 kW	13760 kg/h	75/61.2 0.22196 kPa/m 1.33266 m/s	90/73.6 0.09136 kPa/m 0.92144 m/s	110/90.0 0.03472 kPa/m 0.61622 m/s	
170 kW	255 kW	340 kW	425 kW	510 kW	595 kW	680 kW	14620 kg/h	90/73.6 0.10196 kPa/m 0.97903 m/s	110/90.0 0.03874 kPa/m 0.65473 m/s		
180 kW	270 kW	360 kW	450 kW	540 kW	630 kW	720 kW	15480 kg/h	90/73.6 0.11308 kPa/m 1.03662 m/s	110/90.0 0.04296 kPa/m 0.69325 m/s		
190 kW	285 kW	380 kW	475 kW	570 kW	665 kW	760 kW	16340 kg/h	90/73.6 0.12472 kPa/m 1.09421 m/s	110/90.0 0.04738 kPa/m 0.73176 m/s		

Heating pipe: rapid design

Spread							Mass flow	Pipe type Δp.v	Pipe type Δp.v	Pipe type Δp.v
ΔT= 10K	ΔT=15K	ΔT=20K	ΔT=25K	ΔT=30K	ΔT=35K	ΔT=40K				
200 kW	300 kW	400 kW	500 kW	600 kW	700 kW	800 kW	17200 kg/h	90/73.6 0.13687 kPa/m 1.15180 m/s	110/90.0 0.05199 kPa/m 0.77028 m/s	
210 kW	315 kW	420 kW	525 kW	630 kW	735 kW	840 kW	18060 kg/h	90/73.6 0.14953 kPa/m 1.20939 m/s	110/90.0 0.05680 kPa/m 0.80879 m/s	
220 kW	330 kW	440 kW	550 kW	660 kW	770 kW	880 kW	18920 kg/h	90/73.6 0.16269 kPa/m 1.26698 m/s	110/90.0 0.06179 kPa/m 0.84730 m/s	
230 kW	345 kW	460 kW	575 kW	690 kW	805 kW	920 kW	19780 kg/h	90/73.6 0.17635 kPa/m 1.32457 m/s	110/90.0 0.06697 kPa/m 0.88582 m/s	
240 kW	360 kW	480 kW	600 kW	720 kW	840 kW	960 kW	20640 kg/h	90/73.6 0.19051 kPa/m 1.38216 m/s	110/90.0 0.07234 kPa/m 0.92433 m/s	
250 kW	375 kW	500 kW	625 kW	750 kW	875 kW	1000 kW	21500 kg/h	110/90.0 0.07790 kPa/m 0.96285 m/s		
260 kW	390 kW	520 kW	650 kW	780 kW	910 kW	1040 kW	22360 kg/h	110/90.0 0.08364 kPa/m 1.00136 m/s		
270 kW	405 kW	540 kW	675 kW	810 kW	945 kW	1080 kW	23220 kg/h	110/90.0 0.08956 kPa/m 1.03987 m/s		
280 kW	420 kW	560 kW	700 kW	840 kW	980 kW	1120 kW	24080 kg/h	110/90.0 0.09567 kPa/m 1.07839 m/s		
290 kW	435 kW	580 kW	725 kW	870 kW	1015 kW	1160 kW	24940 kg/h	110/90.0 0.10196 kPa/m 1.111690 m/s		
300 kW	450 kW	600 kW	750 kW	900 kW	1050 kW	1200 kW	25800 kg/h	110/90.0 0.10843 kPa/m 1.15541 m/s		
310 kW	465 kW	620 kW	775 kW	930 kW	1085 kW	1240 kW	26660 kg/h	110/90.0 0.11507 kPa/m 1.19393 m/s		
320 kW	480 kW	640 kW	800 kW	960 kW	1120 kW	1280 kW	27520 kg/h	110/90.0 0.12190 kPa/m 1.23244 m/s		
330 kW	495 kW	660 kW	825 kW	990 kW	1155 kW	1320 kW	28380 kg/h	110/90.0 0.12890 kPa/m 1.27096 m/s		
340 kW	510 kW	680 kW	850 kW	1020 kW	1190 kW	1360 kW	29240 kg/h	110/90.0 0.13608 kPa/m 1.30947 m/s		
350 kW	525 kW	700 kW	875 kW	1050 kW	1225 kW	1400 kW	30100 kg/h	110/90.0 0.14344 kPa/m 1.34798 m/s		

For sizing pipes, the following equation applies

$$Q = \dot{m} C_p \Delta T$$

Where Q = heating power (kW) C_p = water specific heat capacity
 \dot{m} = mass flow rate kg/s ΔT = temperature difference

The following table enables determination of the pressure loss at a specified flow rate. It is recommended to keep the pressure loss below 0.3kPa/m.

Heating pipe: Basis 50°C water temperature*

DIM:		25 x 2.3	32 x 2.9	40 x 3.7	50 x 4.6	63 x 5.8	75 x 6.8	90 x 8.2	110 x 10
di (mm)		20.4	26.2	32.6	40.8	51.4	61.4	73.6	90.0
Volume flow		kPa/m m/s		kPa/m m/s		kPa/m m/s		kPa/m m/s	
l/h	l/s	kPa/m m/s		kPa/m m/s		kPa/m m/s		kPa/m m/s	
36	0.01								
72	0.02								
108	0.03								
144	0.04								
180	0.05	0.020	0.162						
216	0.06	0.028	0.194						
252	0.07	0.037	0.226						
288	0.08	0.047	0.259						
324	0.09	0.058	0.291						
360	0.1	0.071	0.323	0.020	0.191				
720	0.2	0.244	0.646	0.069	0.381	0.024	0.243		
1080	0.3	0.507	0.969	0.143	0.572	0.049	0.365		
1440	0.4	0.850	1.293	0.239	0.762	0.082	0.487	0.028	0.310
1800	0.5	1.270	1.616	0.358	0.953	0.122	0.608	0.041	0.388
2160	0.6	1.765	1.939	0.496	1.143	0.169	0.730	0.058	0.466
2520	0.7	2.330	2.262	0.655	1.334	0.223	0.852	0.076	0.543
2880	0.8	2.966	2.585	0.834	1.524	0.284	0.973	0.097	0.621
3240	0.9	3.668	2.908	1.031	1.715	0.351	1.095	0.119	0.699
3600	1	4.438	3.231	1.247	1.905	0.425	1.217	0.144	0.776
3960	1.1	5.272	3.555	1.481	2.096	0.504	1.338	0.171	0.854
4320	1.2	6.171	3.878	1.733	2.286	0.590	1.460	0.200	0.931
5040	1.4	8.156	4.524	2.290	2.668	0.779	1.703	0.265	1.087
5760	1.6	10.388	5.170	2.916	3.049	0.992	1.947	0.337	1.242
6480	1.8	12.859	5.816	3.609	3.430	1.227	2.190	0.417	1.397
7200	2	15.566	6.463	4.367	3.811	1.485	2.433	0.504	1.552
7920	2.2	18.504	7.109	5.190	4.192	1.764	2.677	0.599	1.708
8640	2.4	21.670	7.755	6.077	4.573	2.065	2.920	0.701	1.863
9360	2.6	25.060	8.402	7.026	4.954	2.387	3.163	0.810	2.018
10080	2.8	28.671	9.048	8.037	5.335	2.730	3.407	0.926	2.173
10800	3	32.500	9.694	9.109	5.716	3.094	3.650	1.049	2.329
12600	3.5	43.015	11.310	12.051	6.669	4.092	4.258	1.388	2.717
14400	4	54.847	12.926	15.360	7.622	5.214	4.867	1.768	3.105
16200	4.5			19.029	8.574	6.458	5.475	2.189	3.493
18000	5			23.050	9.527	7.821	6.083	2.650	3.881
19800	5.5			27.418	10.480	9.301	6.692	3.151	4.269
21600	6			32.127	11.432	10.896	7.300	3.690	4.657
23400	6.5			37.172	12.385	12.604	7.908	4.268	5.046
25200	7					14.425	8.516	4.884	5.434
27000	7.5					16.357	9.125	5.537	5.822
						1.815	3.664	0.773	2.571
						0.322	1.787	0.123	1.196

Heating pipe: Basis 50°C water temperature*

DIM:		25 x 2.3	32 x 2.9	40 x 3.7	50 x 4.6	63 x 5.8	75 x 6.8	90 x 8.2	110 x 10
di (mm)		20.4	26.2	32.6	40.8	51.4	61.4	73.6	90.0
Volume flow		kPa/m m/s		kPa/m m/s		kPa/m m/s		kPa/m m/s	
l/h	l/s	kPa/m m/s		kPa/m m/s		kPa/m m/s		kPa/m m/s	
28800	8			18.398 9.733	6.227 6.210	2.041 3.908	0.869 2.742	0.362 1.906	0.138 1.276
30600	8.5			20.548 10.341	6.954 6.598	2.279 4.153	0.970 2.913	0.404 2.025	0.154 1.356
32400	9			22.806 10.950	7.717 6.986	2.528 4.397	1.076 3.085	0.448 2.144	0.171 1.435
34200	9.5			25.170 11.558	8.516 7.374	2.790 4.641	1.187 3.256	0.495 2.264	0.188 1.515
36000	10			27.639 12.166	9.350 7.762	3.062 4.886	1.303 3.427	0.543 2.383	0.207 1.595
37800	10.5				10.220 8.151	3.347 5.130	1.424 3.599	0.593 2.502	0.226 1.675
39600	11				11.125 8.539	3.643 5.374	1.550 3.770	0.646 2.621	0.246 1.754
43200	12				13.038 9.315	4.268 5.863	1.816 4.113	0.756 2.859	0.288 1.914
46800	13				15.089 10.091	4.939 6.351	2.101 4.456	0.875 3.098	0.333 2.073
50400	14				17.275 10.867	5.653 6.840	2.405 4.798	1.001 3.336	0.381 2.233
54000	15				19.595 11.644	6.412 7.328	2.727 5.141	1.135 3.574	0.431 2.392
57600	16				22.048 12.420	7.213 7.817	3.067 5.484	1.277 3.812	0.485 2.552
61200	17					8.057 8.306	3.426 5.827	1.426 4.051	0.542 2.711
64800	18					8.944 8.794	3.802 6.169	1.582 4.289	0.601 2.871
68400	19					9.872 9.283	4.197 6.512	1.746 4.527	0.663 3.030
72000	20					10.842 9.771	4.609 6.855	1.917 4.765	0.728 3.190
79200	22					12.906 10.748	5.485 7.540	2.281 5.242	0.866 3.509
86400	24					15.132 11.725	6.430 8.226	2.674 5.719	1.015 3.828
93600	26					17.520 12.703	7.443 8.911	3.095 6.195	1.175 4.147
100800	28						8.523 9.597	3.544 6.672	1.345 4.466
108000	30						9.670 10.282	4.020 7.148	1.525 4.785
115200	32						10.883 10.968	4.523 7.625	1.716 5.104
122400	34						12.161 11.653	5.054 8.101	1.917 5.423
129600	36						13.503 12.339	5.611 8.578	2.128 5.741
136800	38							6.195 9.054	2.350 6.060
144000	40							6.805 9.531	2.581 6.379
162000	45							8.444 10.722	3.201 7.177
180000	50							10.243 11.914	3.883 7.974
198000	55							12.200 13.105	4.623 8.772
216000	60								5.423 9.569
234000	65								6.281 10.367
252000	70								7.196 11.164
270000	75								8.167 11.961
288000	80								9.195 12.759

*Pressure loss correction factors for other water temperatures

°C	10	15	20	25	30	35	40	45	50	55	60	65	70	75	80	85	90	95
Factor	1.217	1.183	1.150	1.117	1.100	1.067	1.050	1.017	1.000	0.983	0.967	0.952	0.938	0.933	0.918	0.904	0.890	0.873

Aqua

Potable water pipe: Basis 50 °C water temperature*

DIM: di (mm)		25 x 3.5 18		32 x 4.4 23.2		40 x 5.5 29		50 x 6.9 36.2		63 x 8.7 45.6	
Volume flow		kPa/m		kPa/m		kPa/m		kPa/m		kPa/m	
l/h	l/s		m/s		m/s		m/s		m/s		m/s
6	0.01										
72	0.02										
108	0.03										
144	0.04										
180	0.05	0.036	0.204								
216	0.06	0.050	0.245								
252	0.07	0.065	0.286								
288	0.08	0.083	0.327								
324	0.09	0.103	0.368								
360	0.1	0.124	0.409	0.037	0.246						
720	0.2	0.429	0.817	0.127	0.492	0.043	0.314				
1080	0.3	0.890	1.226	0.263	0.738	0.089	0.470	0.031	0.301		
1440	0.4	1.494	1.635	0.442	0.984	0.150	0.627	0.051	0.401		
1800	0.5	2.233	2.044	0.660	1.230	0.224	0.784	0.076	0.501		
2160	0.6	3.103	2.452	0.917	1.476	0.311	0.941	0.106	0.601	0.034	0.376
2520	0.7	4.098	2.861	1.210	1.722	0.410	1.097	0.140	0.701	0.045	0.438
2880	0.8	5.215	3.270	1.540	1.968	0.522	1.254	0.178	0.801	0.058	0.501
3240	0.9	6.452	3.678	1.905	2.214	0.645	1.411	0.220	0.902	0.071	0.563
3600	1	7.806	4.087	2.304	2.460	0.780	1.568	0.266	1.002	0.086	0.626
3960	1.1	9.275	4.496	2.737	2.706	0.927	1.724	0.316	1.102	0.102	0.689
4320	1.2	10.857	4.905	3.203	2.952	1.084	1.881	0.370	1.202	0.120	0.751
5040	1.4			4.233	3.444	1.433	2.195	0.489	1.403	0.158	0.876
5760	1.6			5.390	3.936	1.824	2.508	0.622	1.603	0.201	1.002
6480	1.8			6.672	4.428	2.257	2.822	0.769	1.803	0.248	1.127
7200	2			8.075	4.920	2.731	3.135	0.931	2.004	0.301	1.252
7920	2.2			9.598	5.412	3.245	3.449	1.106	2.204	0.357	1.377
8640	2.4			11.239	5.904	3.799	3.762	1.294	2.404	0.418	1.502
9360	2.6					4.392	4.076	1.496	2.605	0.483	1.628
10080	2.8					5.024	4.389	1.711	2.805	0.552	1.753
10800	3					5.694	4.703	1.939	3.005	0.626	1.878
12600	3.5					7.532	5.486	2.564	3.506	0.827	2.191
14400	4					9.599	6.270	3.266	4.007	1.053	2.504
16200	4.5							4.045	4.508	1.304	2.817
18000	5							4.898	5.009	1.579	3.130
19800	5.5							5.824	5.510	1.877	3.443
21600	6							6.823	6.011	2.198	3.756
23400	6.5							7.892	6.512	2.542	4.069
25200	7							9.032	7.013	2.908	4.382
27000	7.5							10.240	7.514	3.297	4.695
28800	8									3.708	5.008
30600	8.5									4.140	5.321
32400	9									4.594	5.634
34200	9.5									5.069	5.947
36000	10									5.566	6.260
37800	10.5									6.083	6.573
39600	11									6.621	6.886
43200	12									7.759	7.512
46800	13									8.979	8.138
50400	14									10.279	8.764

*Pressure loss correction factors for other water temperatures

°C	10	15	20	25	30	35	40	45	50	55	60	65	70	75	80	85	90	95
Factor	1.208	1.174	1.144	1.115	1.087	1.060	1.039	1.019	1.000	0.982	0.965	0.954	0.943	0.928	0.923	0.907	0.896	0.878

Supra

Potable water/cooling water pipe: Basis 20°C water temperature

V	25 / 20.4 / 2.3		32 / 26.2 / 2.9		40 / 32.6 / 3.7		50 / 40.8 / 4.6		63 / 51.4 / 5.8		75 / 61.4 / 6.8		90 / 73.6 / 8.2		110 / 90.0 / 10.0	
	v	Δp	v	Δp	v	Δp	v	Δp	v	Δp	v	Δp	v	Δp	v	Δp
[l/s]	[m/s]	[bar/ 100 m]	[m/s]	[bar/ 100 m]	[m/s]	[bar/ 100 m]	[m/s]	[bar/ 100 m]	[m/s]	[bar/ 100 m]	[m/s]	[bar/ 100 m]	[m/s]	[bar/ 100 m]	[m/s]	[bar/ 100 m]
0.025	0.076	0.0086														
0.0315	0.096	0.0127	0.059	0.0041												
0.04	0.122	0.0189	0.075	0.0061												
0.05	0.153	0.0275	0.094	0.0088	0.060	0.0031										
0.063	0.193	0.0407	0.119	0.0130	0.075	0.0045										
0.08	0.245	0.0611	0.151	0.0195	0.096	0.0067	0.061	0.0024								
0.1	0.306	0.0895	0.188	0.0285	0.120	0.0098	0.076	0.0034								
0.125	0.382	0.1315	0.235	0.0417	0.150	0.0144	0.096	0.0050	0.060	0.0017						
0.16	0.490	0.2016	0.301	0.0638	0.192	0.0219	0.122	0.0076	0.077	0.0026	0.054	0.0011				
0.2	0.612	0.2974	0.377	0.0939	0.240	0.0321	0.153	0.0111	0.096	0.0037	0.068	0.0016				
0.25	0.765	0.4394	0.471	0.1384	0.300	0.0473	0.191	0.0163	0.120	0.0055	0.085	0.0024	0.059	0.0010		
0.315	0.964	0.6599	0.593	0.2072	0.377	0.0706	0.241	0.0244	0.152	0.0082	0.107	0.0036	0.074	0.0015		
0.4	1.224	1.0068	0.753	0.3152	0.479	0.1071	0.306	0.0369	0.193	0.0123	0.136	0.0054	0.094	0.0023	0.063	0.0009
0.5	1.530	1.4972	0.942	0.4672	0.599	0.1585	0.382	0.0544	0.241	0.0182	0.170	0.0079	0.118	0.0033	0.079	0.0013
0.63	1.927	2.2631	1.187	0.7039	0.755	0.2381	0.482	0.0816	0.304	0.0272	0.214	0.0119	0.148	0.0049	0.099	0.0019
0.8	2.448	3.4774	1.507	1.0776	0.958	0.3634	0.612	0.1242	0.386	0.0413	0.272	0.0180	0.188	0.0075	0.126	0.0029
1	3.059	5.2062	1.883	1.6072	1.198	0.5405	0.765	0.1842	0.482	0.0611	0.340	0.0266	0.235	0.0111	0.157	0.0043
1.25			2.354	2.4022	1.498	0.8053	0.956	0.2738	0.602	0.0906	0.425	0.0394	0.294	0.0163	0.196	0.0063
1.6			3.014	3.7567	1.917	1.2547	1.224	0.4253	0.771	0.1403	0.544	0.0609	0.376	0.0252	0.252	0.0097
2					2.396	1.8774	1.530	0.6345	0.964	0.2088	0.680	0.0904	0.470	0.0374	0.314	0.0143
2.5					2.995	2.8148	1.912	0.9483	1.205	0.3112	0.850	0.1345	0.588	0.0555	0.393	0.0212
3.15							2.409	1.4406	1.518	0.4714	1.071	0.2033	0.740	0.0838	0.495	0.0320
4							3.059	2.2247	1.928	0.7254	1.360	0.3123	0.940	0.1285	0.629	0.0489
5									2.410	1.0873	1.700	0.4670	1.175	0.1917	0.786	0.0729
6.3									3.036	1.6567	2.142	0.7098	1.481	0.2908	0.990	0.1103
8											2.720	1.0965	1.880	0.4480	1.258	0.1695
10											3.399	1.6493	2.350	0.6722	1.572	0.2537
12.5													2.938	1.0104	1.965	1.3804
16															2.515	0.5966
20															3.144	0.8977



Flow rates

Flow rates have a considerable influence on the cost-efficiency and operational safety of a supply system. High flow rates result in high pressure losses and high dynamic pressure losses can occur. Furthermore, particles which have been deposited on the pipe walls may become entrained. Low flow rates result in long retention times whereby the water can become cloudy or contaminated with germs. Adequate water exchange must be observed.



Dimensioning of lines for industrial water

The dimensioning of pipelines carrying water for domestic use must ensure there is sufficient water supply at each of the tap connections. The pipeline system dimensions must ensure that in the case of the lowest absolute pressure, each tap connection is sufficiently supplied.



Note:

Please observe DIN 1988 and the DVGW Work Sheet W551, which include some new items referring to district heating supply.

Planning

Design basics

Lining up the elements

The flexible piping system allows you to plan the trenches flexibly and take the environment into account. When the pipe element is led into the building, the selection of the entry location must take into account the space requirements of the element bending radius.

Linking

The implementation of the most profitable system in terms of operation and installation costs is best done using multiple pipe elements. Thermal loss is the least in the Quattro products, which are particularly well suited to implementation in terraced houses and small apartment buildings. The number of joints in the ground can be reduced for small buildings by

using the linking technique. The technique is particularly well suited to locations where houses are lined up and the dimensions of the Quattro products are adequate. The floor space required by Quattro is very small, allowing for linking joints to be made inside the apartments. For example, the raised base of the hallway cabinet can be used as the linking space.

Building-specific lines

In developments consisting of several buildings, straight connections from the house to the boiler room are recommended if the boiler room is located in a central location. Installation between buildings is fast straight off the coil and no connections are required. Trenches do not have to be kept open for pressure testing. The used

pipe sizes are not large and this allows the use of multiple pipe elements.

Combining products

Radiator-equipped hot tap water systems can be used with the larger circulation pipe elements Quattro and Aqua Twin. The benefits offered by twin and four-pipe elements can be taken advantage of in these locations. By combining products, a functional system can be created and efficient use of the chambers can be guaranteed.

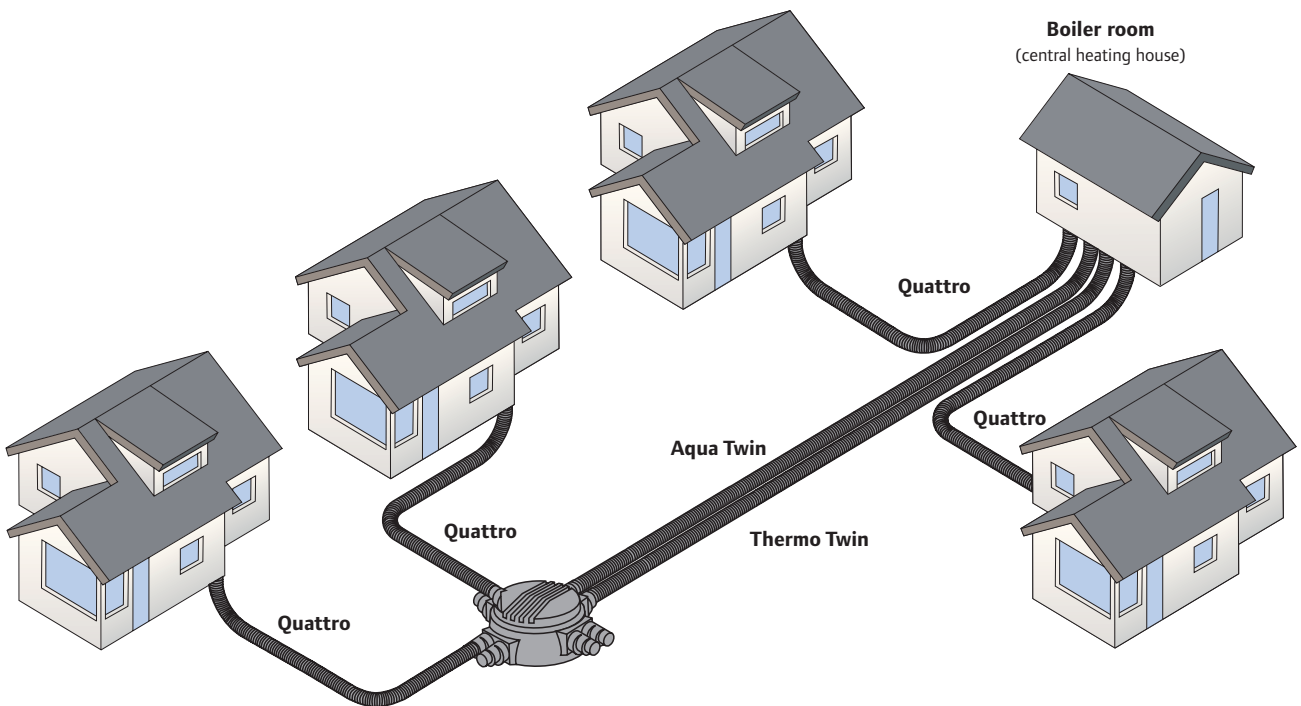

Planning the route

The flexibility of Uponor Pre-Insulated pipes allows them to be adapted to almost any type of routing conditions on site. Existing lines can be crossed over or under, and obstacles simply detoured.

The system requires only a shallow narrow trench to be excavated. During installation, the pipe trenches outside of the pipe connections and branches need normally not be walked over so sufficient working space should be created at these points. In any case of changes in pipeline direction the various pipe systems must not fall below the permissible minimum bending radii. The excavated soil can be deposited on just one side of the trench. The pipeline is then rolled out on the other side direct into the trench. It is essential to avoid damage to the jacket pipe.

The trench must have a sandy bed, free of stones. Sand particle size should be 0 to 2/3 mm. Avoid any pointed or sharp-edged objects in the trench. The pipeline must be carefully embedded (at least 10 cm below and above the jacket pipe and between the trench walls) as this has a decisive impact on the service life of the jacket pipe. When determining the minimum coverage, any possible damage through subsequent construction work during the whole of the service life must be taken into consideration. The filling material must be



compacted layer for layer, from 500 mm the coverage must also be compacted by machine. Then place the routing barrier tape and fill in the trench. The jacket pipes remain stable under earth and SLW (heavy traffic load) of $h=0.5$ m up to max. 6 m. The required static evidence is verified according to the current regulation ATV-DVWK-A127 for embedded pipes. The verification applies only to certain installation conditions.

Minimum coverage without traffic load

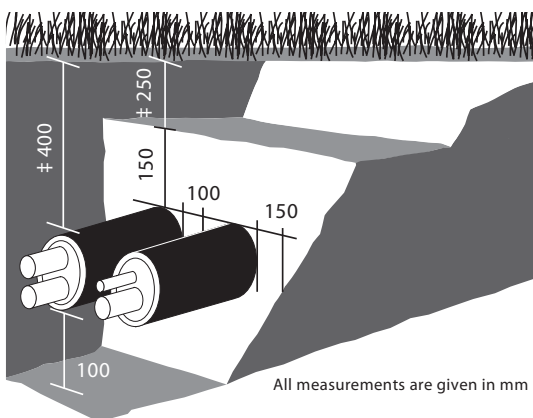



Warning ⚠ local frost lines have not been taken into consideration!

Coverage with heavy traffic load (SLW 60)



Examples of Installations

1. House lead-in : Thermo Twin



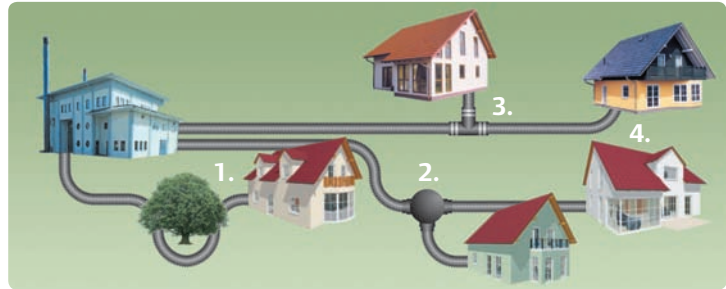



Product	Number	
Uponor rubber end cap	1	
Uponor Wipex male connectors	2	
Uponor Wipex joint	2	





2. Chamber installation Uponor Thermo Twin

Product	Number	
Uponor chamber	1	
Uponor heat-shrinkable tube for chamber	3	
Uponor insulation tape for heat-shrinkable tube	1	
Uponor rubber end caps	3	
Uponor Wipex male connectors 6 bar	6	
Uponor Wipex T-pieces	2	

3. T-piece with reduced jacket pipe and medium pipe dimensions Uponor Thermo Twin





Product	Number	
Uponor T-insulation set	1	
Uponor reducer rings for straight and T-insulation sets	2	
Uponor Wipex male connectors	6	
Uponor Wipex T-pieces	2	
Uponor Wipex reducers	4	
Uponor rubber end caps	3	

4. Wall sleeve Uponor Thermo Twin

Product	Number	
Uponor wall seal pressure water-proof	1	
Uponor rubber end cap	1	
Uponor Wipex male connectors	2	
Uponor Wipex joint	2	





Supply of adjacent building with heating water from house to house

Product	Number	
Uponor Thermo Twin	1	
Uponor rubber end caps	2	
Uponor Wipex male connectors	4	
Uponor Wipex joint	4	

Supply of adjacent building with heating water and warm water, including circulation

Product	Number	
Uponor Quattro	1	
Uponor rubber end caps	2	
Uponor wall seal pressure water-proof PWP	2	
Uponor Wipex male connectors 6 bar	4	
Uponor Wipex male connectors 10 bar	4	
Uponor Wipex joint	8	

Supply of adjacent building with potable water from house to house

Product	Number	
Uponor Supra	1	
Uponor rubber end caps	2	
Uponor plastic male connectors	2	

Notes on Processing and Installation

Standard values for installing Uponor pre-insulated pipe systems



The time taken to install the pipe systems depends on local circumstances. In the following table, obstacles, undercrossings, weather conditions, set-up times

and other such factors have not been taken into account, neither the employment of auxiliary aids such as excavators or cable winches.

Pipe type	25 metre fitters / Duration [mins.]	50 metre fitters / Duration [mins.]	100 metre fitters / Duration [mins.]
Single:			
25	2 / 15	2 / 30	3 / 40
32	2 / 15	2 / 30	3 / 40
40	2 / 20	2 / 40	3 / 60
50	2 / 20	2 / 40	3 / 60
63	3 / 20	3 / 40	4 / 60
75	3 / 25	3 / 50	4 / 75
90	3 / 30	4 / 60	5 / 90
110	3 / 30	4 / 60	5 / 90
Twin:			
25	2 / 20	2 / 40	3 / 60
32	2 / 20	2 / 40	3 / 60
40	2 / 30	3 / 40	4 / 60
50	3 / 25	3 / 50	5 / 90
63	3 / 30	4 / 60	5 / 90
Quattro:			
	2 / 30	3 / 40	4 / 60

Standard values for average installation times for connections and accessories:

Number of fitters/group minutes per item (e.g. 2/15 = 2 fitters requires 15 mins. per item)

Uponor rubber end caps	1 / 5
Uponor Wipex male connectors	2 / 15
Uponor Wipex fitting	2 / 30
Uponor Wipex T-piece (complete)	2 / 40
Uponor straight insulation set	1 / 20
Uponor T-insulation set	1 / 30
Uponor elbow insulation set	1 / 30
Uponor chamber incl. 6 x outlets for jacket pipe	2 / 50
Uponor wall sleeve NPW (non-pressure water-proof)	1 / 30
Uponor wall seal pressure water-proof PWP	1 / 30
Uponor house lead-in, pressure water-proof (PWP)	1 / 30



The installation times given above are group minutes for the corresponding number of fitters (without trench work). The figures are meant as guidance for calculations.

Two examples to illustrate average, practice relevant installation times for Uponor pre-insulated pipe systems:

Example 1:

- Installation of 2 x 20 m Uponor Thermo-Single pipe, dimensions $d_a = 63$ mm
- 2 fitters, without the use of auxiliary aids

**Installation time: 2 x 10 minutes
(x 2 fitters = 40 mins.)**

Example 2:

- Installations of 2 x 130 m Uponor Thermo-Single pipes, dimension $d_a = 110$ mm
- Several undercrossings of intercrossed lines and several changes of direction
- 8 fitters, 1 excavator, cable winch and guide pulley

**Installation time: 2 x 90 minutes
(x 8 fitters = 1440 mins.)**

Pipe handling

Storing, lifting and handling the pipe coil

Conical end caps have been mounted on the ends of the pipes to protect the flow pipes against sunlight and other damage, including soiling during transportation. Protect the pipe coil from sharp objects during transportation and storage.

Do not drag the coil across rough surfaces. Ensure that the coil is not squashed and that the pipe is not dented when bent during storage. Store all coils in a horizontal position. Pipe coils and chambers can be stored outside, other components of the system should be stored indoors.

When unloading, do not drop the coils. Do not transport a pipe coil by pulling it. Use belts for lifting the coil.

Please note!

When lifting pipe coils, use at least a 50 mm diameter nylon or textile loop. If you are lifting the coils with a fork truck or other similar equipment, the forks must be rounded or padded. Due to the flexibility and weight of the coils, the diameter of the coils can vary by up to 30 cm.

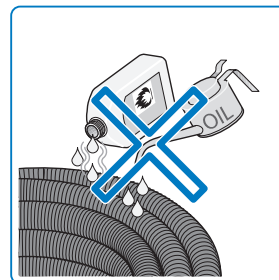
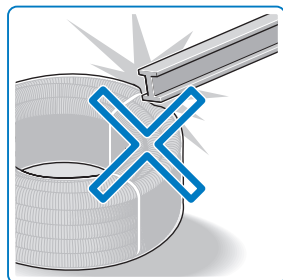
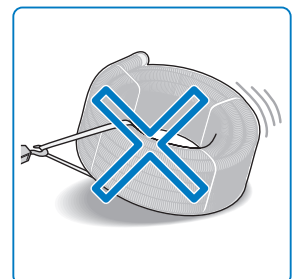
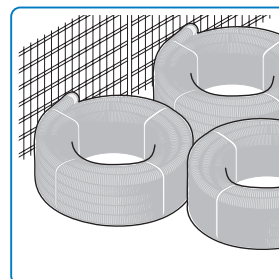
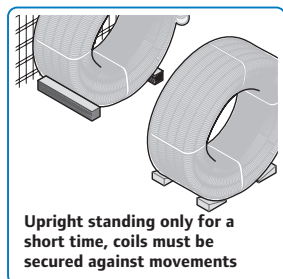
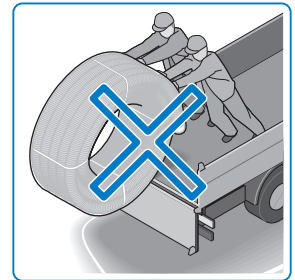
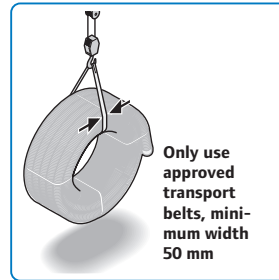
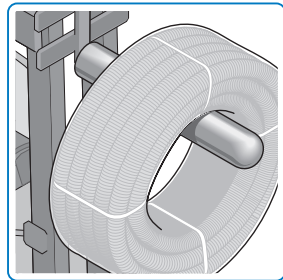
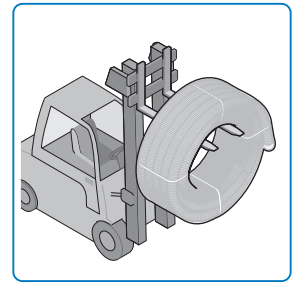
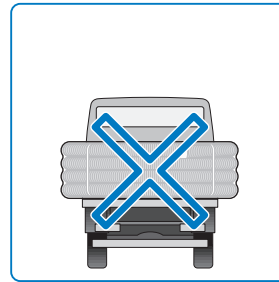
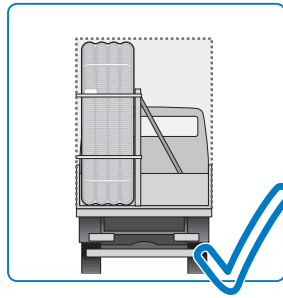

Please note!
Plastic materials must never be brought into contact with aggressive substances such as motor fuel, solvents, timber preservative or similar.

Uncoiling

Store the delivered coil as far as possible in its protective packaging until installation! Then uncoil the pipe directly into or beside the trench. Never pull the pipe across the ground as pointed objects could cause damage. Should the jacket pipe become damaged, it can be repaired using a shrinkable sleeve.

All pipeline parts and system accessories must be visually inspected prior to installation or processing for damage of influences which impact its function. Parts which are inacceptably impacted must be discarded! If the pipeline is to be installed horizontally in the open, support points (for example, using sand) must be provided to prevent the pipe from slipping later. If the ground is uneven, these

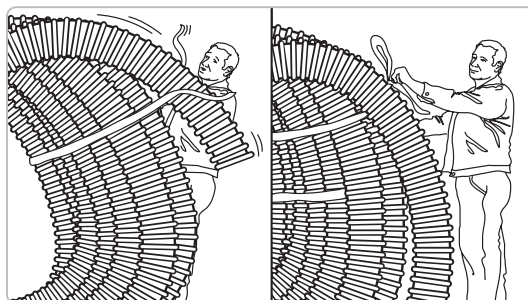

Fig. 1

Fig. 2



Warning:

The pipe ends could whiplash when the textile tapes are opened (see Fig. 1). Therefore make sure the coils are always secured with two to three tapes. (see Fig. 2).

supports must be provided every 25 metres.

When embedding pipe sections, a sufficiently free pipe length of 3 to 5 metres must be provided for installing the connecting systems. Where there is a change of material from steel to plastic medium pipe, stress may be transferred from the steel to the plastic pipe during

temperature changes. In this case, shear forces particularly are to be avoided; if necessary, provide fixed points around the ends of the steel medium pipe. If installing in extremely low temperatures (increased pipe rigidity), the pipes should be stored in a heated hall or carry out the installation beneath a heated shelter directly at the trench.

Rolling out the pipes from the inside .

(recommended for jacket pipe diameters 140 mm and 175 mm or coiled lengths up to 100m):

Do not remove exterior packaging! Cut the nylon securing tapes in the coil. Take out the inner pipe end from the coil (do not remove the end cap until the pipe is connected!). Fix the pipe ends (e.g. by weighing them down or placing sand on top of them). Roll out the pipe, coil by coil.

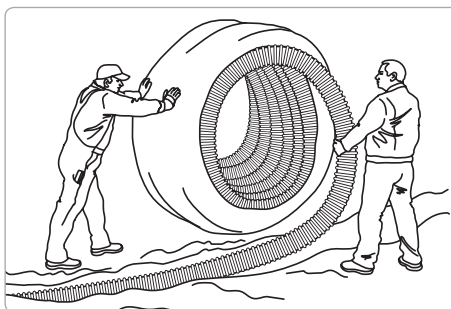

Rolling out the pipe from the outside.

(recommended for jacket pipe diameters 200 mm or coiled lengths in excess of 100 m):

Remove the packaging foil. Open the first nylon tape at the outside pipe end, loosen the pipe end from the coil and fix the coil once more with the nylon tape. Warning – when opening the first nylon tape, the pipe end is under tension and can whiplash! Fix the loose pipe end (e.g. by weighing it down or placing sand on it) and roll out as far as the next nylon tape. Repeat this process until the coil is completely unrolled.

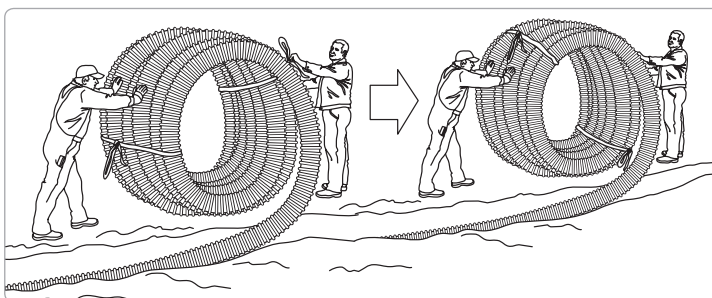

Anchoring

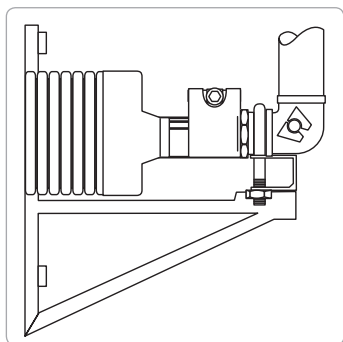

Fixing to pipe elbow with a pipe clamp

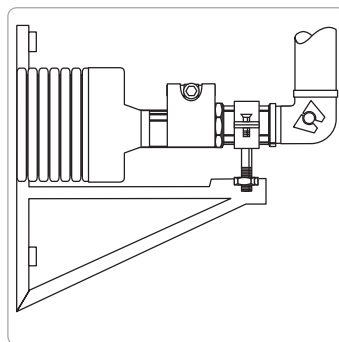

Fixing to a fixed point joint with a pipe clamp

The expansion behaviour of PE-X material leads to slight changes in the length of the medium pipe therefore a tension-free connection must be provided by a pipe bend or a fixed point joint.

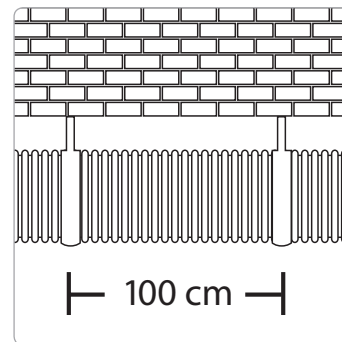

Wall and ceiling installation

The Uponor pipe system can be fixed to any wall or ceiling using simple pipe clamps at intervals of 100 cm to prevent the pipe from sagging.

Installation in cold temperatures

Installation is not recommended to be carried out in temperatures below -15°C. In cold weather, installation is easier if the pipes are

already warm, for example from having been stored in a warm space prior to the installation. On a construction site, heating can also

be carried out using a hot air blower. Heating the pipes over an open fire is prohibited.

Bending radii in mm

Product	25	32	40	50	63	75	90	110
Uponor Thermo Single	250	300	350	450	550	800	1100	1200
Uponor Thermo Twin	500	600	800	1000	1200			
Uponor Aqua Single	350	400	450	550	650	900	1200	1300
Uponor Aqua Twin	650	700	900	1000				
Uponor Quattro	800	800						
Uponor Supra	200	250	300	400	500	600	700	1200
Uponor Thermo Mini	200	250						



Mounting Instructions

Uponor WIPEX fittings

WIPEX is a complete set of fittings that fits Uponor PEX pipes used in hot tap water and heating systems and certain industrial applications.

WIPEX fittings are used for pipes with an external diameter of 25-110 mm and pressure class of 6 or 10 bar. Required combinations

of fittings are created using WIPEX parts. Joints are sealed using the o-rings, supplied with the fittings.

WIPEX parts
Check that the o-ring housing is clean. Only use the o-rings supplied with the connectors. Place the o-ring in the intended groove. Fasten all parts manually, if at all possible. Tighten the parts using a spanner or a pipe-wrench with small jaws all the way down (metal against metal). When other parts are mounted on the Wipex connectors or pipe parts, the threaded coupling must be tightened using flax (hemp).

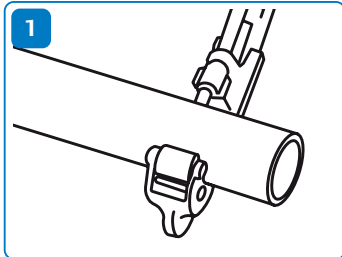

Cut the pipe at a right angle using a pipe cutter intended for plastic pipes.

Please note! Do not use a saw as this may cause shavings to be left in the pipe. These shavings may block the valves at a later stage.

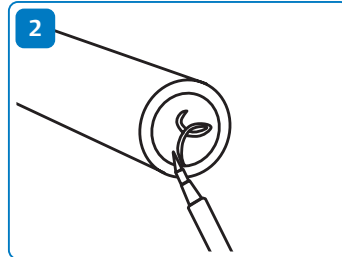

Bevel the pipe from the inside using a bevelling tool or a knife and remove possible bevels left outside the pipe.

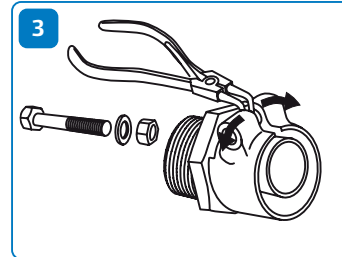

Remove the outer sleeve from the connector. Remove the bolt and spread the outer sleeve using a pair of pliers.

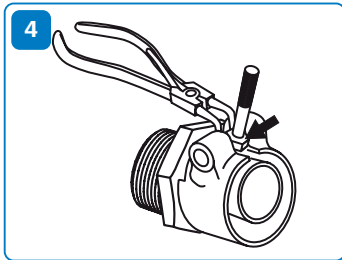

Place the bolt between the outer sleeve jaws and remove the outer sleeve.

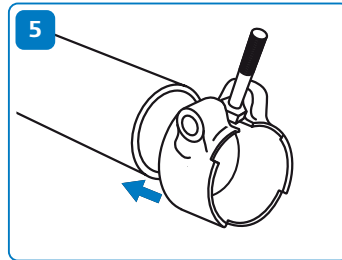

Push the outer sleeve over the pipe. **Please note!** Check that the outer sleeve has been turned in the correct position (the juts must be pointing towards the support sleeve). Installation of the pipe is easy and the o-ring remains undamaged when the o-ring is lubricated using a suitable lubricant (for example silicone spray).

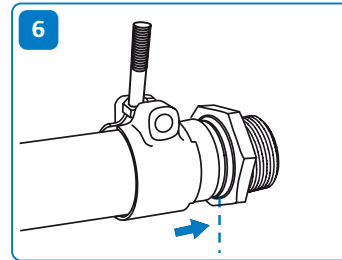

The pipe is pushed into the support sleeve all the way until the pipe stopper. Install the outer sleeve so that the anchoring groove is placed in the outer sleeve juts.

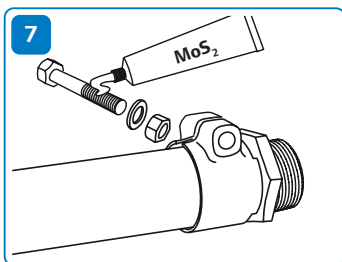

Tighten the WIPEX fittings. Lubricate the threads and washer of the bolt prior to tightening it. Use a suitable type of grease, such as silicone grease. Tighten the nut carefully using a spanner. Hold the bolt in place using a second spanner while tightening the bolt.

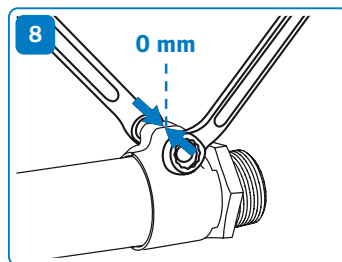

Tighten the outer sleeve so that its jaws touch. Tighten again carefully. If the jaws do not touch, wait for at least 30 minutes before re-tightening them.

Uponor rubber end caps

The rubber end caps are always used at the pipe ends. They protect the insulation against moisture and provide partitions between components.

Installing the rubber end caps

Put the end caps in place before the couplings.

Please note!

Follow also the instructions for the Uponor insulation sets.

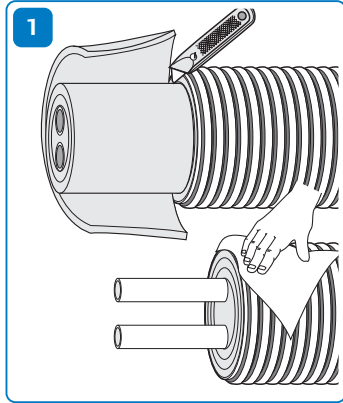

1 Cut away jacket pipe and peel off insulation layers so that enough flow pipe is visible to join the coupling and the end cap. Be careful not to damage the flow pipe. Clean the surfaces carefully.

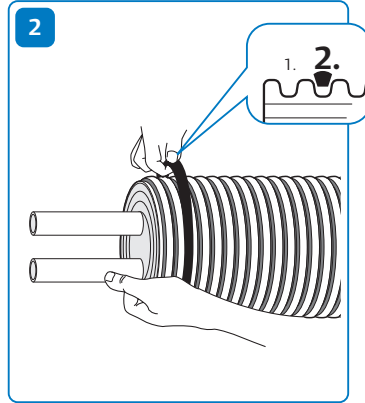

2 Install the rubber seal in the second groove.

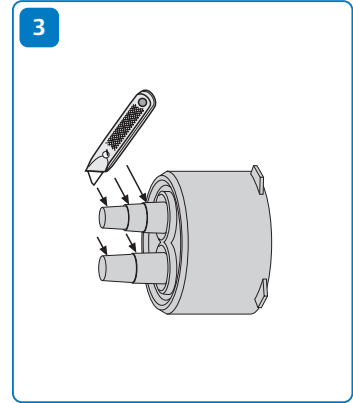

3 Open outlets on the rubber end cap according to the flow pipe size.

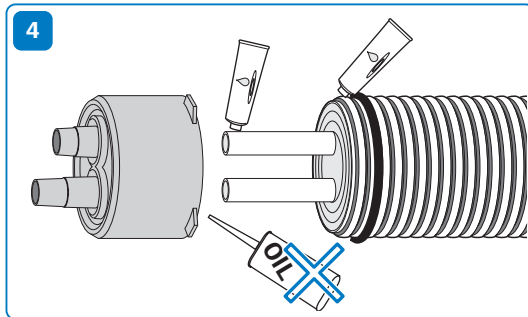

4 Install the end cap over the end of the pipe using lubricant. A non oil-based lubricant can assist.

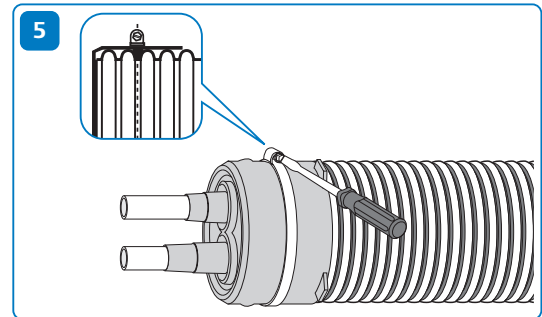

5 Position the jubilee clip over the seal and tighten.

Uponor insulation sets

Example: T-branches

Uponor insulation sets are designed to protect underground joint areas from heat loss, external loading forces and water ingress. The T insulation set is designed for use with both twin and single pipe branches and is compatible with three jacket pipe dimensions

(140/175/200). Pipes with a 68mm jacket can also be fitted to the insulation sets using reducer rings (supplied separately).

Each set is supplied with two PUR foam half-shells, spacer pieces, sealant, joining bolts with washers and full installation instructions.

Please note!

Conduct the pressure test before closing the T-insulation set.

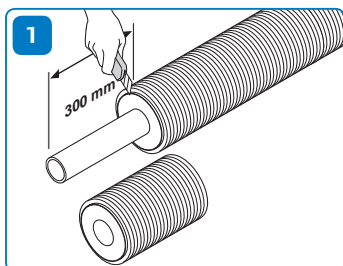

1 Cut back outer jacket.

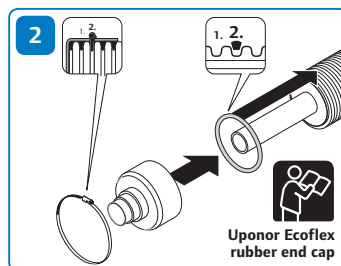

2 Fit rubber end cap.

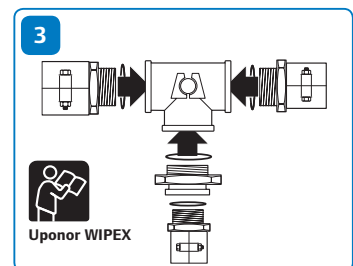

3 Assemble Wipex fittings.

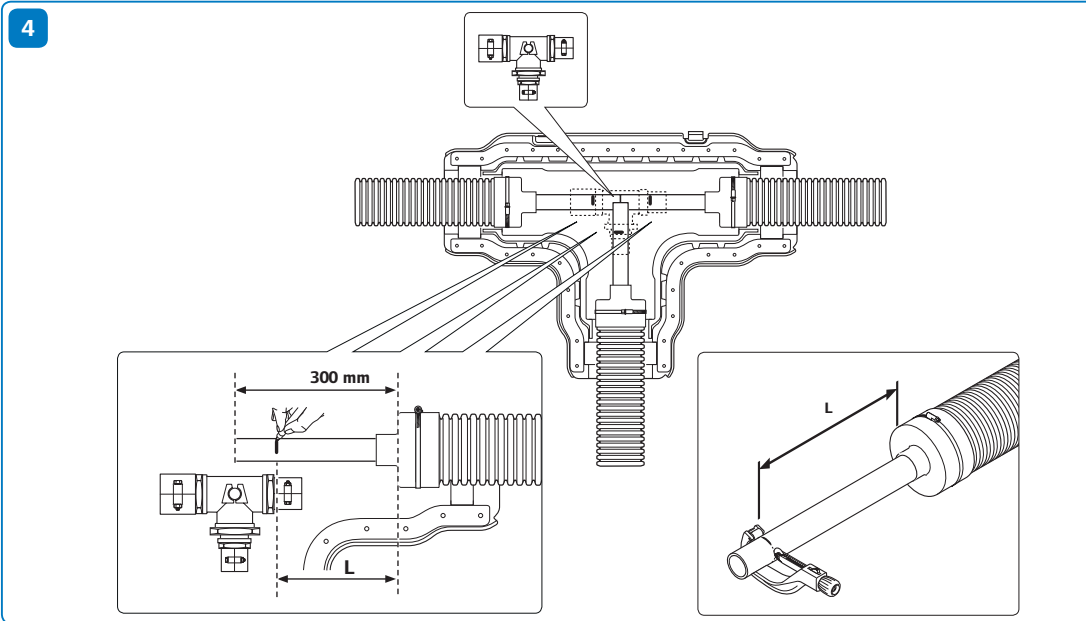

Trim back exposed pipe ends to suit the assembly of Wipex fittings.

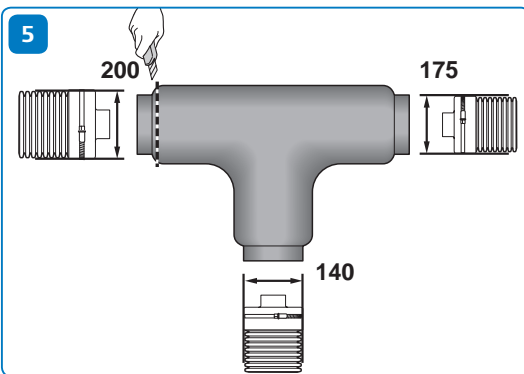

If using 200mm jacket pipe, trim back foam half-shell.

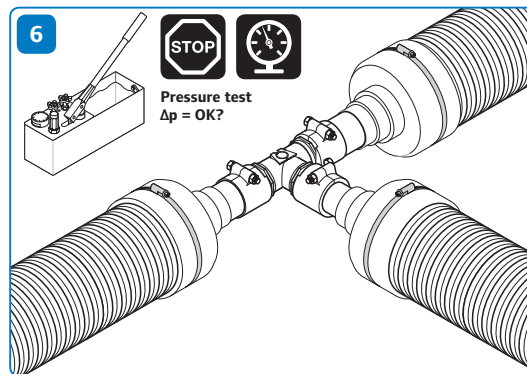

Connect up and pressure test.

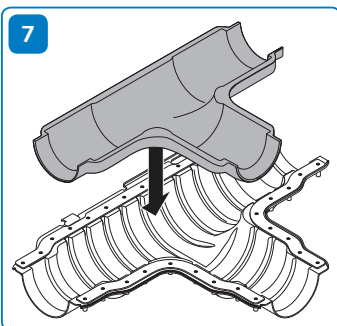

Place foam half-shell in casing.

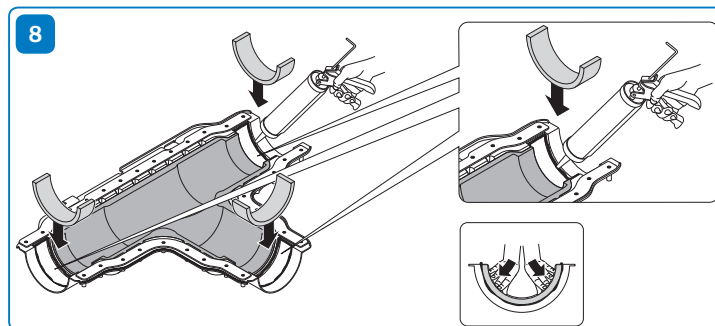

Fit spacer pieces to suit jacket pipe size using sealant.

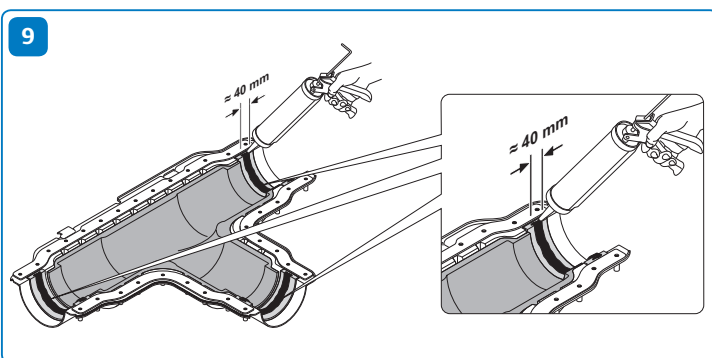

Apply sealant to spacer pieces.

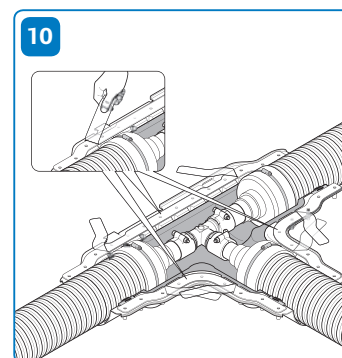

Partially release adhesive strips.

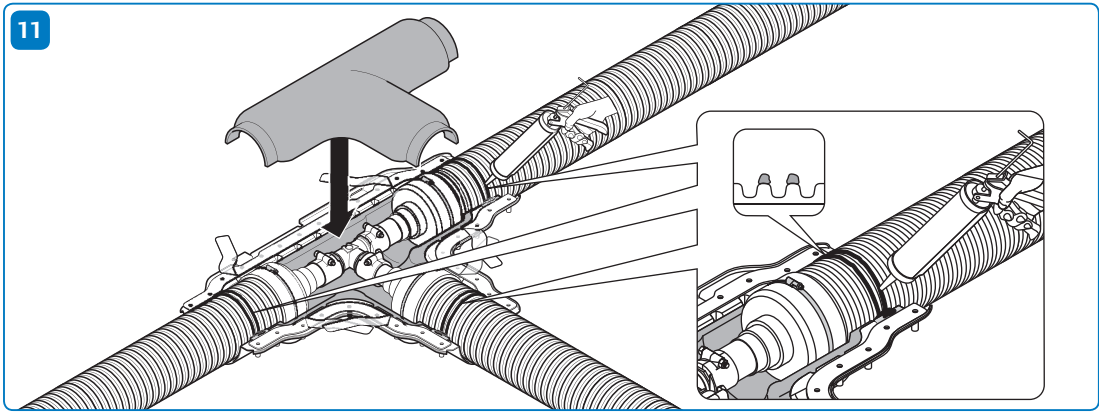

11 Position upper foam half-shell over joint area. Apply sealant to two corrugations where pipe meets spacer piece.

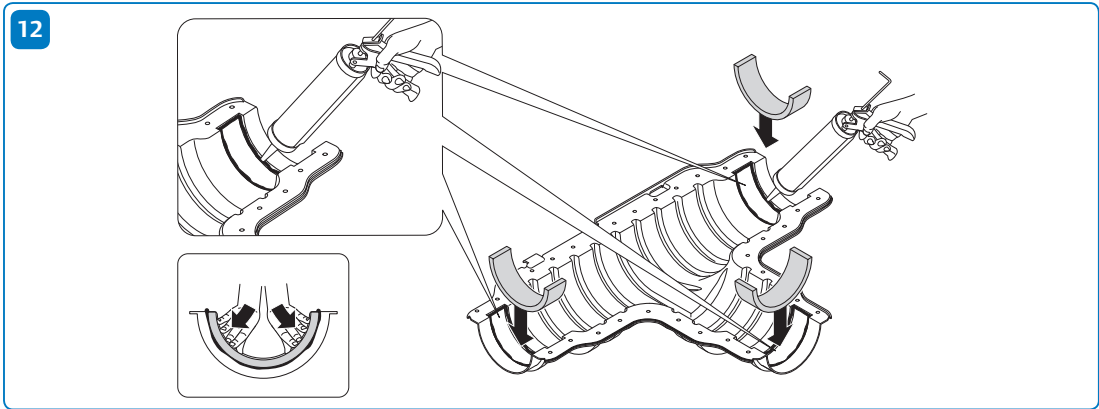

12 Prepare top half of insulation set casing.

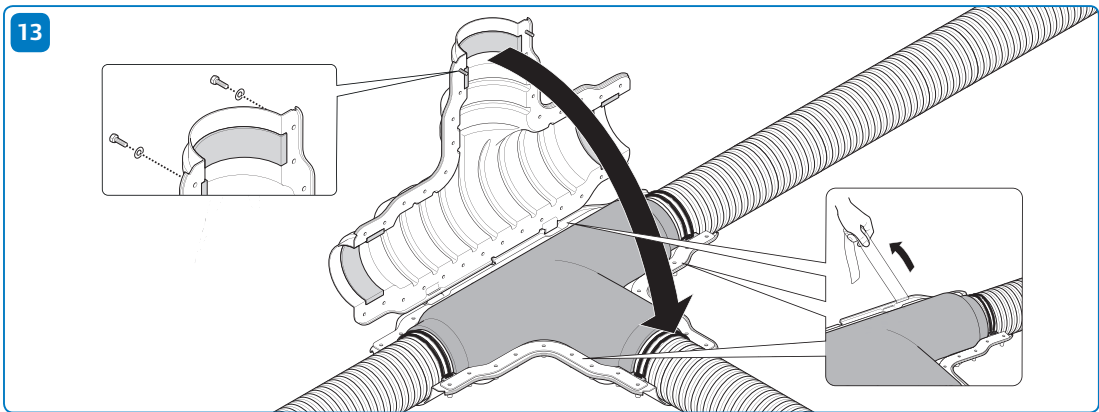

13 Fully release adhesive strips and position top half of casing over joint area.

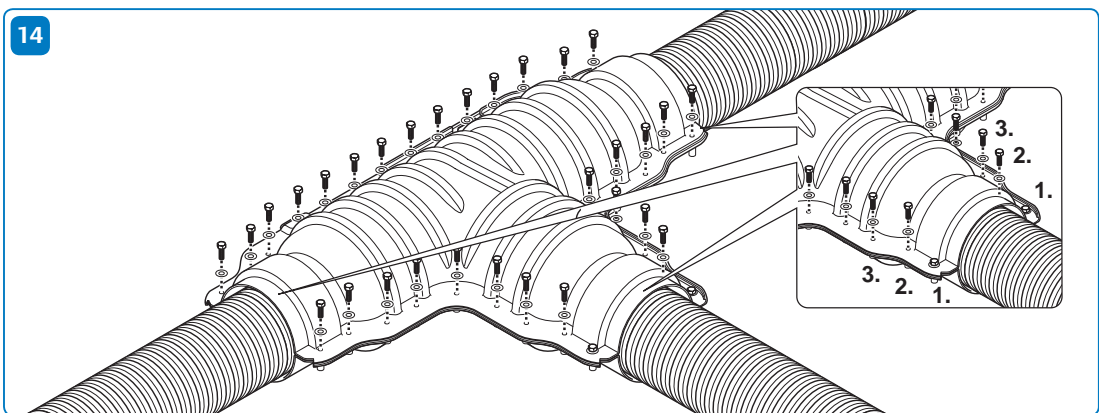

14 Complete assembly of insulation set using bolts provided.

Uponor Chamber

The Uponor branching chamber can be used for all pipe dimensions (140 – 200 mm). The chamber is available in both T and X models. End caps are always used in chambers.

Preparing the trench

Level the bottom of the trench with sand and compress the sand. If required, install an anchoring slab beneath the levelling layer.

The normal depth of the chamber cover is 50 cm. 30 cm depth is permitted if no direct load is placed on top of the chamber.

Installing the chamber

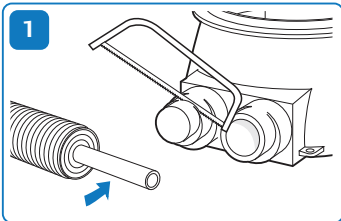

1 Cut open branches of the chamber according to the required pipe size. Peel off enough of the jacket pipe and insulation to make the joint, 10-20 cm depending on the pipe size.

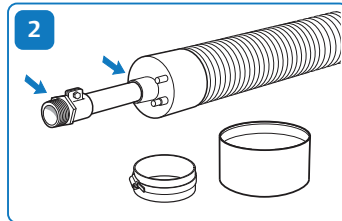

2 Put the end caps and their seals in place at the ends of the pipes. Mount the connectors to the ends of the flow pipes. Slide the shrink sleeves onto the pipes.

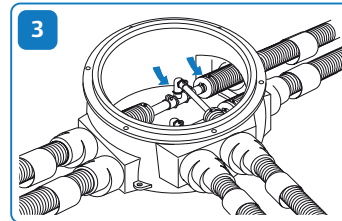

3 Push the pipes into the chamber. Fasten the rubber end caps on the jacket pipe using jubilee clips. Join the pipes and tighten the couplings.

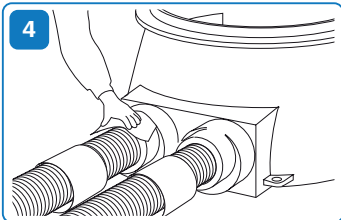

4 Roughen up the surface of the jacket and the chamber joint with sand paper around the shrink sleeve. Wipe the joint area clean.

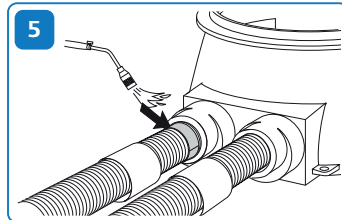

5 Preheat the area that is left under the shrink sleeve using a soft gas flame. Remove the protective paper from the sleeve and place the sleeve around the joint.

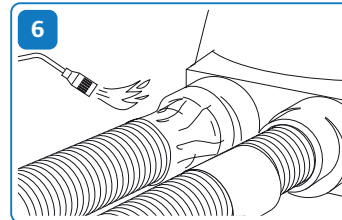

6 Shrink it with a soft gas flame according to the instructions on the shrink sleeve. First shrink the end near the chamber, then shrink towards the pipe element. Keep the flame in constant movement.

Filling the trench

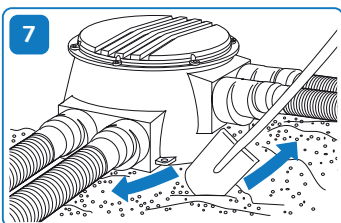

7 Close the chamber lid, but tighten the bolts only after the pipeline has been pressure tested. Begin filling the trench by pushing sand underneath the joints.

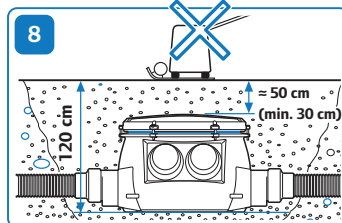

8 Start the filling using a shovel, be careful not to damage the shrink sleeves. Check that the chamber stays upright. Compress the fill in layers of approximately 20-30cm. Mechanical compression directly above the chamber is forbidden.

Special cases:

Traffic load: A concrete slab can be used above the chamber to distribute the load. Without a protective slab, a chamber installed in a 50 cm cover depth can withstand an occa-

sional short term load of 3,000 kg (= 6,000 kg/m²; for example, a tractor driving over it). Long-term loading is permissible until 500 kg (= 1,000 kg/m²; for example, a parked car).

If ground water can rise up to the chamber, the use of an anchoring slab is recommended.

Uponor feed-through kits (non-pressure-waterproof)

The feed-through package is used to seal an underground feed-through in a concrete wall. The feed-through sleeve is cast into place allowing for the installation of the pipe at a later date. The shrink sleeve prevents water from leaking into the foundation between the pipe and the feed-through sleeve. The feed-through seal efficiently seals the feed-through in a concrete structure and prevents moisture from entering the building.

Installing the feed-through sleeve

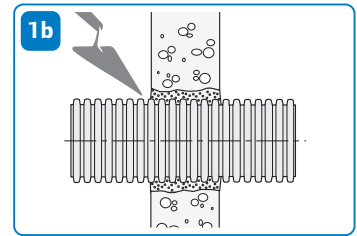
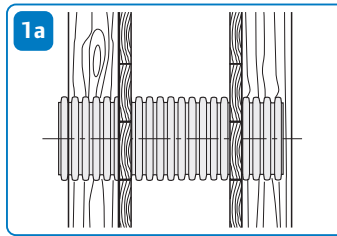

Place the feed-through sleeve in the structure where the pipe element will be placed and cast into place at a later stage. Please note that at least 10 cm of the sleeve pipe should be left outside the cast.

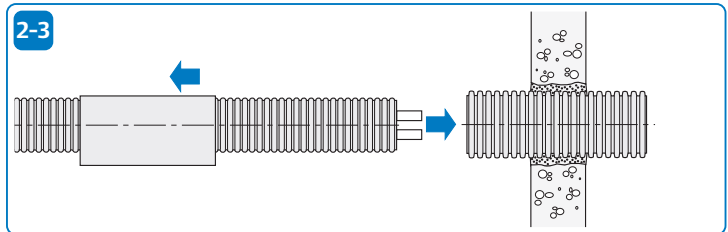

Install the shrink sleeve on top of the pipe element.
Push the pipe element through the feed-through sleeve.

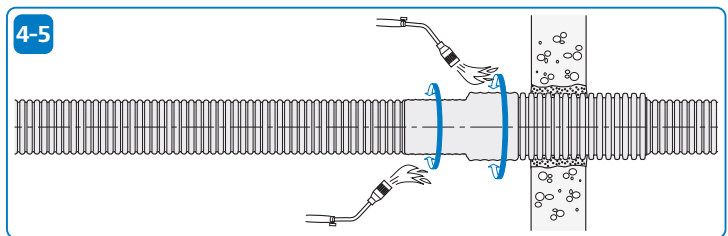

Place the shrink sleeve centrally in the joint between the sleeve pipe and the pipe element and remove any paper that may be left inside the shrink sleeve.

Heat the shrink sleeve with a gas burner using a yellow flame. When the surface of the shrink sleeve is smooth and adhesive is extruding from the ends of the shrink sleeve, the shrink sleeve has received enough warmth. Installation is ready when the shrink sleeve has cooled down to the ambient temperature.

Uponor PWP wall seal (pressure-waterproof)

Installation of Uponor PWP wall seal into the core hole or Uponor fibre cement pipe PWP

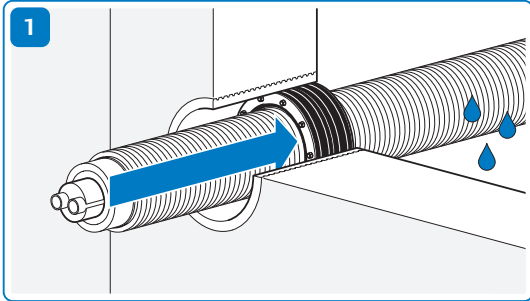

1 Insert the PWP wall seal as far as the water side (outside) – nuts face the cellar side

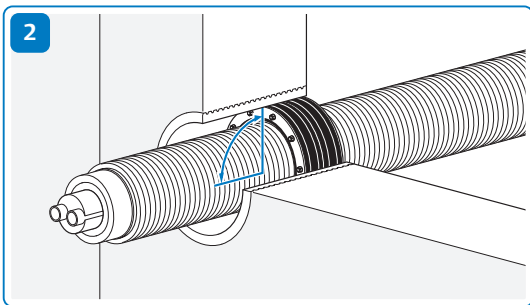
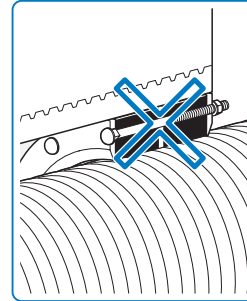
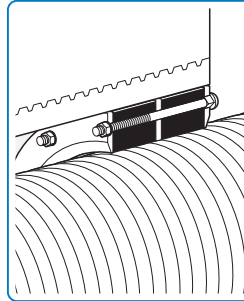

2 Install Uponor PWP wall seal pipe at right angles to Uponor pipe

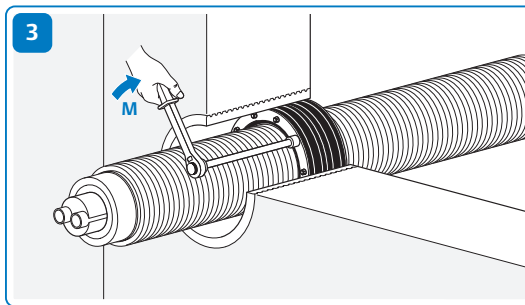

3 During final assembly, successively tighten up each nut with torque-wrench clockwise until the maximum torque M_{max} is reached. Tighten the nuts several times. Repeat the procedure after two hours.

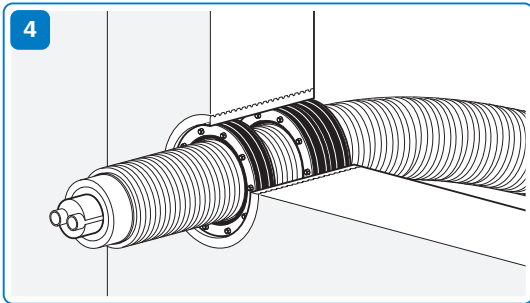

4 Use Uponor PWP supplementary set to reduce tension

Pressure test, leak test in accordance with DIN 1988, Part 2

Legal information

Pressure tests are services performed under a service contract and form part of the contractual performances of the contractor even if they are not mentioned in the description of performances to be rendered.

According to applicable and valid standards, pressure tests must be carried out before the system is placed in operation. In order to establish that the connection is leakproof, the test must be carried out before the connection is insulated and sealed.

Execution of pressure test

The finished but not yet covered pipelines are filled with filtered water so that they are free of air.

The pressure test is to be carried out as a preliminary and as a main test.

Preliminary test

For the preliminary test, a test pressure corresponding to permissible operating overpressure plus 5 bar is applied every 10 minutes twice for a period of 30 minutes. Then after a further test period of 30 minutes, the test pressure must not drop by no more than 0.6 bar (0.1 every 5 minutes) and there must be no leakages.

Main test

The main test must be carried out immediately following the preliminary test. The test lasts for 2 hours. The test pressure read off after the preliminary test must not fall more than 0.2 bar after 2 hours and there must be no leakages anywhere in the tested unit.

Plastic pipes

The material properties of plastic pipes lead to an elongation of the pipe during the pressure test which can influence the test results. Temperature differences between the pipe and the test medium caused by high thermal expansion coefficients of plastic pipes might also influence test results whereby a change in temperature of 10 K corresponds roughly to a change in pressure of 0.5 to 1 bar. Efforts should therefore be made to ensure that during the pressure test, the temperature of the test medium remains as constant as possible. During the pressure test, a visual inspection of all the connections should also be carried out as experience has shown that small leakages are not always noticed by observing the pressure gauge. The pipelines must be thoroughly purged after the pressure test.

Note: Local requirements for pressure testing can differ from this example.

Pressure test diagram

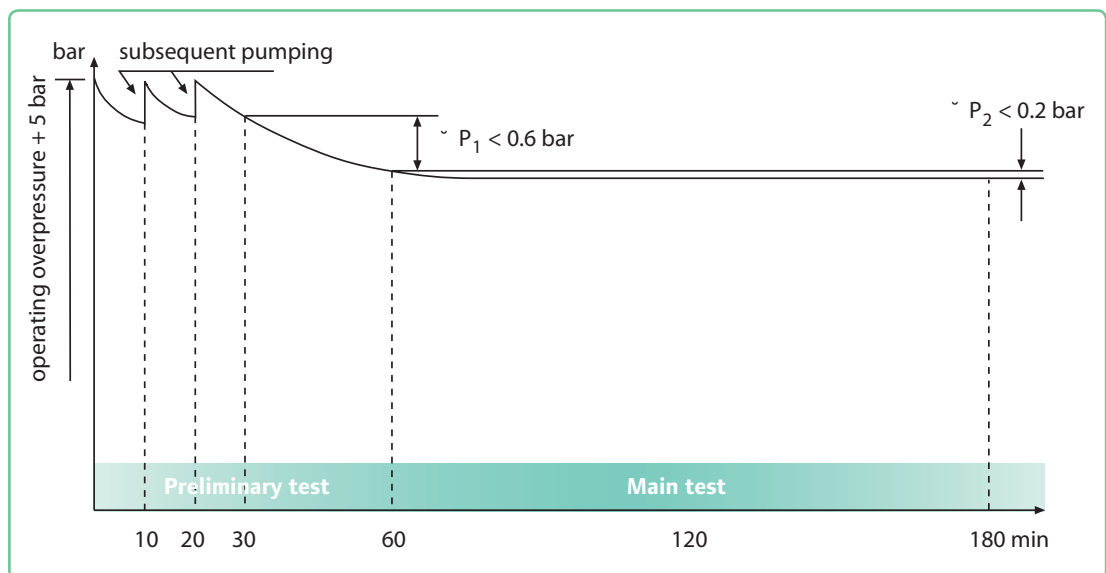

MASTER COPY

Pressure test protocol

Construction project: _____

Ordering party: _____

Installation company: _____

Temperatures: Water temperature: _____ °C Ambient temperature: _____ °C

Lines filled with filtered water are free of air

Preliminary test

(in certain cases, this counts as the main test)

Test duration: 60 minutes Test pressure: operating overpressure + 5 bar

Pressure after 30 minutes (test start): _____ bar

Pressure after 60 minutes (final pressure): _____ bar (pressure drop max. 0.6 bar)

Final result of preliminary test: _____

Leakages observed

Main test

Test duration: 120 minutes max.permissible pressure drop: 0.2 bar

Pressure at test start: _____ bar (from final pressure in preliminary test)

Pressure after 120 minutes (final pressure): _____ bar (pressure drop max. 0.2 bar)

Final result of main test: _____

Leakages observed

Start of test

End of test

Place

Date

Ordering party (representative)

Installation company (representative)

Technical Specifications

Properties of the Uponor PE-Xa medium pipes (up to 95°C)



Aqua

The DVGW-approved medium pipes in the Uponor Aqua product series are suitable for transporting warm potable water up to 95°C at a pressure of max. 10 bar. The PE-Xa medium pipe is produced in line with DIN16892/16893 with a diameter wall thickness ratio of SDR 7.4.



Mechanical properties	Standards	Temperature	Standard value	Unit
Density			938	kg/m ³
Tensile strength	DIN 53455	20 °C	19 – 26	N/mm ²
	DIN 53455	80 °C	9 – 13	N/mm ²
Elasticity module	DIN 53457	20 °C	600 – 900	N/mm ²
	DIN 53457	80 °C	300 – 350	N/mm ²
Elongation at break	DIN 53455	20 °C	350 – 550	%
	DIN 53455	100 °C	500 – 700	%
Impact strength	DIN 53453	-140 °C	no break	kJ/m ²
	DIN 53453	20 °C	no break	kJ/m ²
	DIN 53453	100 °C	no break	kJ/m ²
Moisture absorption	DIN 53472	22 °C	0.01	mg/4d
Friction coefficient with steel			0.08 – 0.1	
Oxygen-Permeability		20 °C	0.8 x 10 ⁻¹³	g m/m ² s bar
		55 °C	3.0 x 10 ⁻¹³	g m/m ² s bar



Thermo

Uponor Thermo medium pipes are coated with an EVAL oxygen diffusion barrier as per DIN 4726 and are thus particularly suited for transporting warm water up to 95°C and a max. pressure of 6 bar. The diameter-wall thickness ratio is SDR 11.

Thermal properties	Standards	Temperature	Standard value	Unit
Application temperature			-50 to +95	°C
Linear coefficient of expansion		20 °C	1.4 x 10 ⁻⁴	m/mK
		100 °C	2.05 x 10 ⁻⁴	m/mK
Softening point			+133	°C
Specific heat			2.3	kJ/kgK
Thermal conductivity	DIN 4725		0.35	W/mK

PE-100 medium pipe (applications up to 20°C)



Supra

The medium pipe in our Uponor Supra pipeline is produced in HDPE (PE 100)*. With a diameter-wall thickness ratio SDR 11 and pressure load of max. 16 bar at 20°C, it is designed specially for transporting cold potable water and for use in cooling water networks. Our HDPE medium pipe is DVGW- approved for transporting potable water.



* To European standard EN12201

Property	Standard	PE 100 (std.values)	Unit
Density at 23 °C	DIN 53479 ISO 1183 ISO/R 1183	approx. 0.96	g/cm ²
Break strength	DIN 53495	38	N/mm ²
Elongation at break	DIN 53495	> 600	%
Tensile strength at yield	DIN 53495	25	N/mm ²
Elasticity module (tensile test)	ISO 178	approx. 1.200	N/mm ²
Hardness	ISO 2039	46	N/mm ²
Vicat-softening point VST-A/50 VST-B/50	DIN/ISO 306	127 77	°C
Thermal conductivity (at 20 °C)	DIN 52612	0.38	W/mK
Application temperature (16 bar)		-10 to +20	°C
Thermal linear expansion coefficient	DIN 53752	1.8 x 10 ⁻⁴	1/°C
Fire behaviour	DIN 4102 Part 1	B2	-

Service life: PE-Xa medium pipe

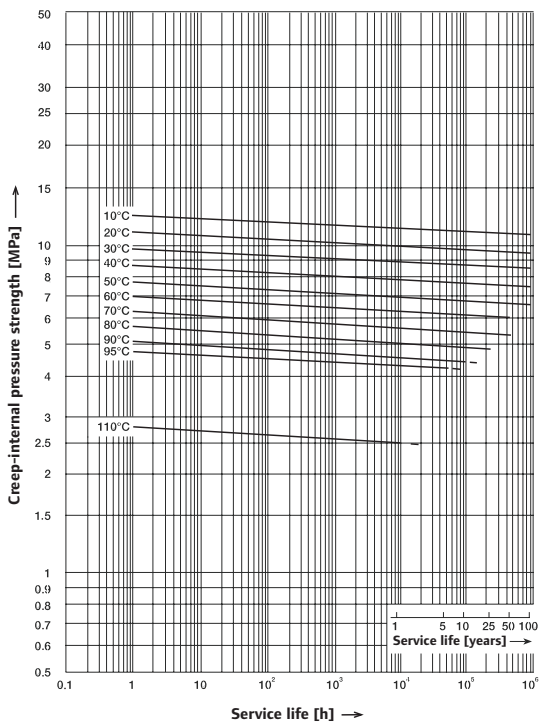

Service life: HDPE medium pipe

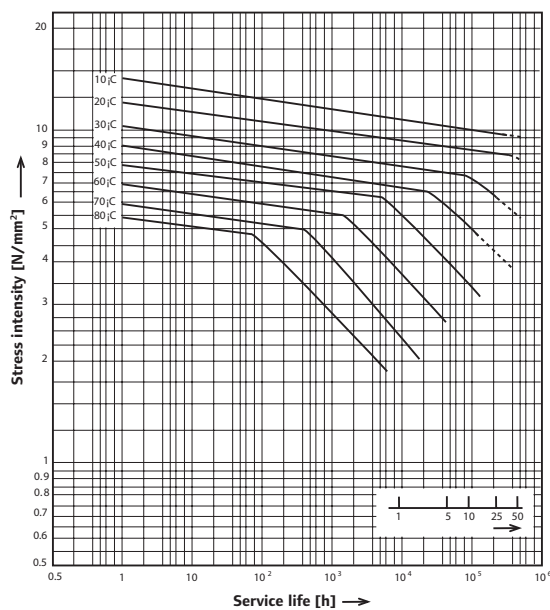

Material properties of the jacket pipe

The stable, impact-resistant PE-HD jacket pipe protects the insulating layer and medium pipe from external influences. The special design of the

pipe geometry ensures a high flexibility on the one hand, high capacity to withstand static loads on the other.

Property	Value	Unit	Method
Material	PE-HD	-	-
UV-stabilised	yes	-	-
Fire behaviour	B2	-	DIN 4102
Density	957 – 959	kg/m ³	ISO 1183
Modulus of elasticity	~ 1000	MPa	ISO 527-2



Material properties of the insulation

The age-resistant insulation consists of crosslinked polyethylene and has, due to its closed cell structure, only minimal water absorption. The multi-

layer design combines maximum flexibility and optimum heat insulation.

Property	Value	Unit	Method
Density	approx. 28	kg/m ³	DIN 53420
Tensile strength	28	N/cm ²	DIN 53571
Operating temperature limits-			
- Minimum	-40	°C	
- Maximum	+95	°C	
Water absorption	< 1,0	volume-%	DIN 53428
Fire behaviour	B2	-	DIN 4102
Compressive strength 50% deformation	73	kPa	DIN 53577
Water vapour transmission/ 10 mm thickness	1,55	g/m ² d	DIN 53429
Ozone depletion potential	0		



Appendix

Weight/volume Tables

Uponor PE-Xa pipes - weight and volume

Tap water pipes (Aqua)

Pipe dim OD x s [mm]	ID [mm]	Weight [kg/m]	Volume [l/m]
25 x 3.5	18.0	0.236	0.24
32 x 4.4	23.3	0.380	0.42
40 x 5.5	29.0	0.592	0.66
50 x 6.9	36.2	0.923	1.03
63 x 8.7	45.6	1.459	1.63
75 x 10.3	54.4	2.077	2.31
90 x 12.4	65.2	2.965	3.26
110 x 15.4	79.8	4.442	4.85

Heating pipes (Thermo)

Pipe dim OD x s [mm]	ID [mm]	Weight [kg/m]	Volume [l/m]
25 x 2.3	20.4	0.183	0.31
32 x 2.9	26.2	0.268	0.50
40 x 3.7	32.6	0.430	0.85
50 x 4.6	40.8	0.665	1.32
63 x 5.8	51.4	1.048	2.08
75 x 6.8	61.2	1.461	2.96
90 x 8.2	73.6	2.113	4.25
110 x 10	90.0	3.141	6.29

Long-term properties

Classification of service conditions according to EN 15632-3 of pre-insulated PE-Xa pipes

The pre-insulated PE-Xa heating pipes and related system components from Uponor are designed according to EN 15632-3 (District heating pipes – Pre-insulated flexible pipe systems – Part 3: Non bonded plastic service pipes; requirements and test methods).

Operating temperatures and service life

The Uponor pre-insulated PE-Xa pipe systems are, according to this

European Standard, designed for a service life of at least 30 years when operated at the following temperature profile:

29 years at 80°C + 1 year at 90°C + 100 h at 95°C.

Other temperature/time profiles can be applied in accordance with EN ISO 13760 (Miner's Rule). Further information is given in prEN 15632-2:2008. Annex A.

The maximum operating temperature shall not exceed 95°C.

Operating pressure

Uponor pre-insulated PE-Xa pipe systems are, in accordance to EN 15632-3, designed for continuous operating pressures of 6 bar (SDR 11) and 10 bar (SDR 7,4).

Heat Loss Charts

Uponor Thermo

Uponor Thermo Single

Thermal conductivity ground: **1.0 W/mK**
 Ground coverage: **0.8 m**

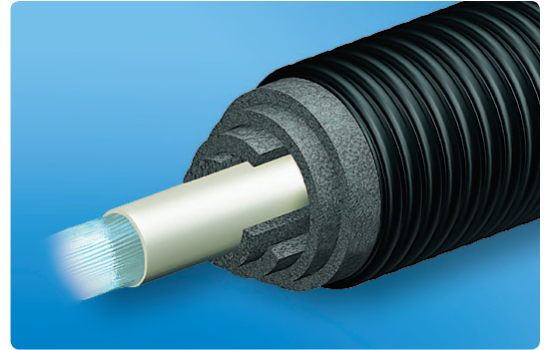

Note!
 Heat loss data in the diagram are calculated with a safety factor of 1,05, according to the requirements of the German "VDI-AG Gütesicherung". Depending on production related tolerance.

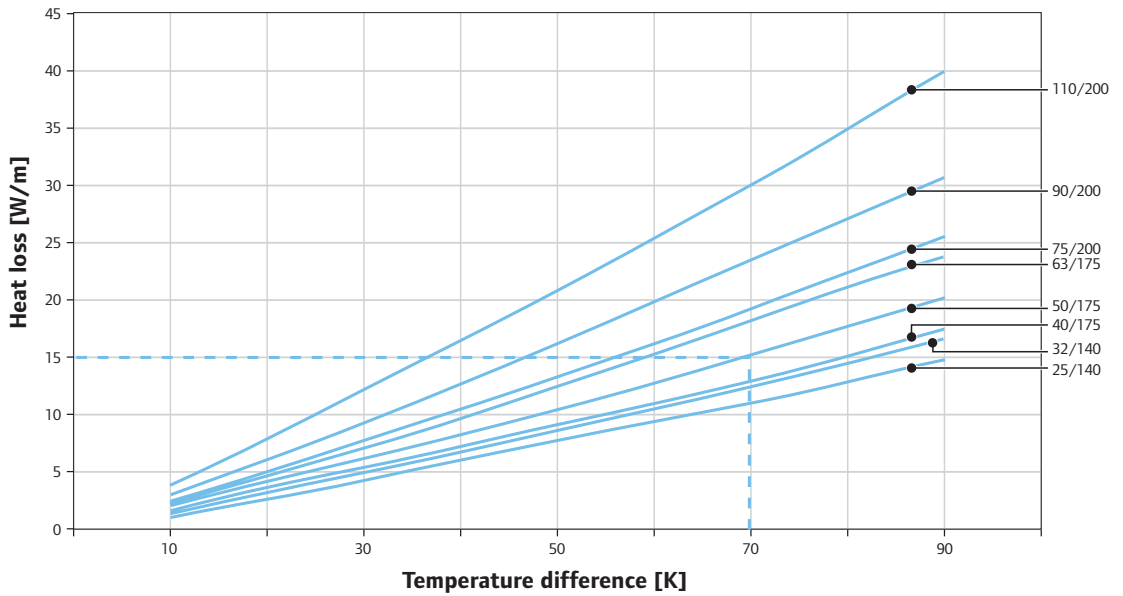

Example for Uponor Thermo Single 50/175

T_M = Medium temperature
 T_E = Ground temperature
 ΔT = Temperature difference (K)

$\Delta T = T_M - T_E$
 $T_M = 75 \text{ }^\circ\text{C}$
 $T_E = 5 \text{ }^\circ\text{C}$
 $\Delta T = 75 - 5 = 70 \text{ K}$
Heat loss: 15.1 W/m



Uponor Thermo Twin

Thermal conductivity ground: **1.0 W/mK**
 Ground coverage: **0.8 m**

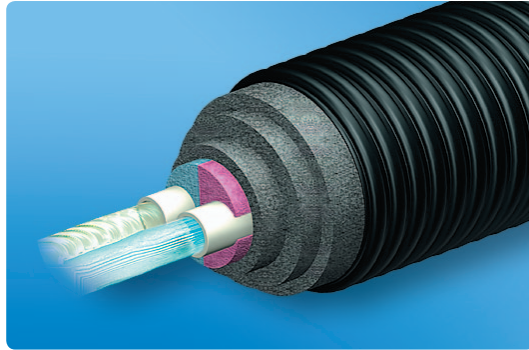

Note!

Heat loss data in the diagram are calculated with a safety factor of 1,05, according to the requirements of the German "VDI-AG Gütesicherung". Depending on production related tolerance.

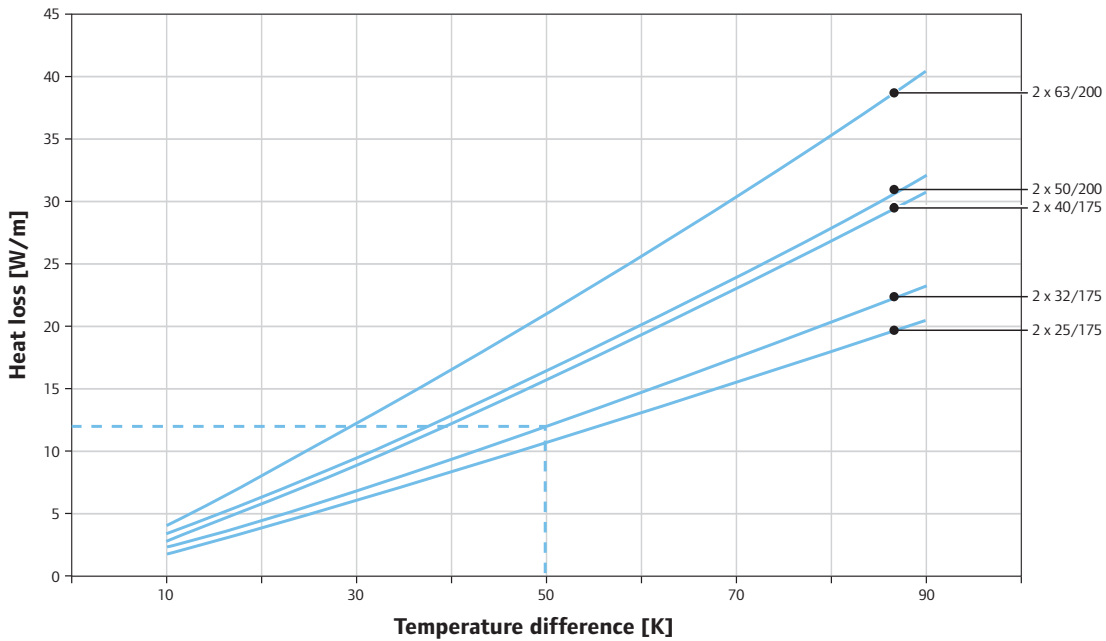

Example for Uponor Thermo Twin 2 x 32/175

T_V = Flow temperature
 T_R = Return temperature
 T_E = Ground temperature
 ΔT = Temperature difference (K)
 $\Delta T = (T_V + T_R)/2 - T_E$
 $T_V = 70\text{ }^\circ\text{C}$
 $T_R = 40\text{ }^\circ\text{C}$
 $T_E = 5\text{ }^\circ\text{C}$
 $\Delta T = (70 + 40)/2 - 5 = 50\text{ K}$
Heat loss: 12 W/m



Uponor Quattro

Thermal conductivity ground: **1.0 W/mK**
Ground coverage: **0.8 m**

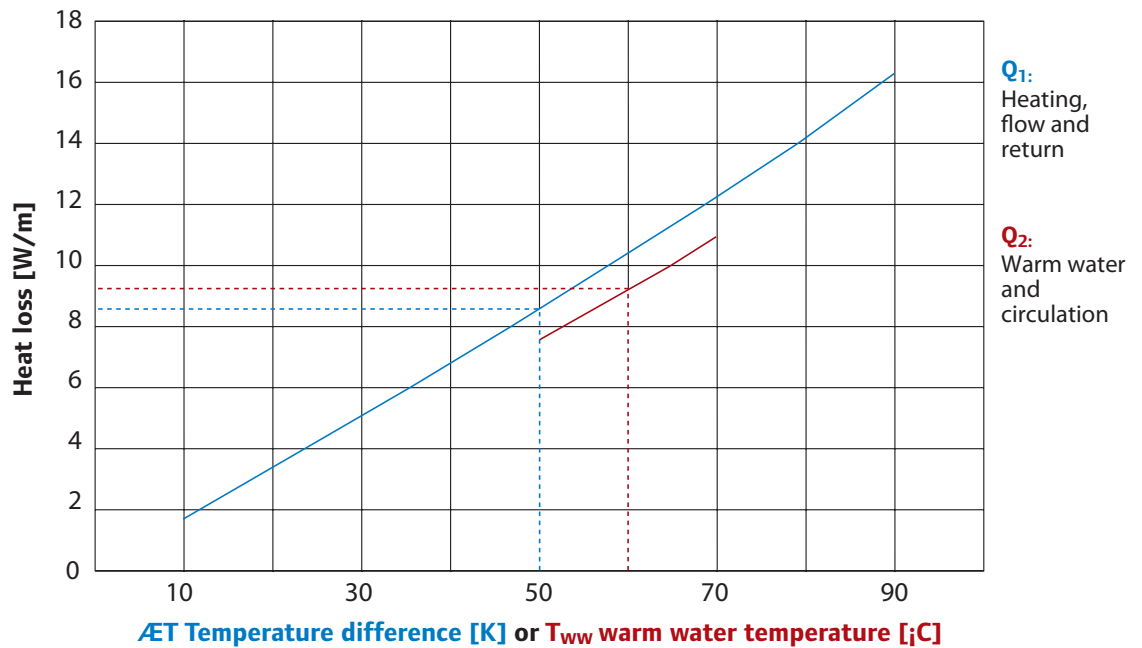

Example for Uponor Quattro

T_V = flow temperature
 T_R = return temperature
 T_E = ground temperature
 ΔT = temperature difference (K)
 T_{ww} = temperature warm water and circulation line
 $\Delta T = (T_V + T_R)/2 - T_E$
 $T_V = 70$ °C
 $T_R = 40$ °C
 $T_E = 5$ °C
 $\Delta T = (70 + 40)/2 - 5 = 50$ K
 $T_{ww} = 60$ °C

It follows therefore that:

Q_1 (at $\Delta T = 50$ K) = 8.5 W/m
 Q_2 (at $T_{ww} = 60$ °C) = 9.2 W/m

Specific heat loss per running metre:

$Q = Q_1 + Q_2 = (8.5 + 9.2) \text{ W/m} = 17.7 \text{ W/m}$



Heat loss checked by
FIW München:
Art.-No.: 1018149

DIN Certco certification

The annual certification according to VDI 2055 verifies the heat loss figures. The heat loss graphs are prepared on this basis. Certification is based on defined layout conditions, which means values are a good reflection of real life.



DIN CERTCO
Gesellschaft für Konformitätsbewertung mbH

CERTIFICATE

The company
UPONOR GmbH
Industriestraße 56
97437 Hassfurt
GERMANY

with the production site in
Ochtrup

hereby receives the confirmation that the product/s

Industrial installation insulation material
Uponor Thermo Single
conforms to

VDI 2055:1994-07
and to the corresponding leaflets of VDI-AG "Gütesicherung" and
to the technical data and the details of the data sheet
Thermo-Single (Edition: 09/2011)
and is granted the licence to use the mark *)

überwacht
nach
VDI 2055
Überwachungsstelle
FIW
FORSCHUNGSINSTITUT FÜR
WÄRMESCHUTZ E.V. MÜNCHEN

in conjunction with the Registration No. below.

Registration No.: 6V046

This Certificate is valid until 2015-03-31.

The test for conformity was conducted by

FIW Forschungsinstitut für
Wärmeschutz e.V. München
Lochhamer Schlag 4
82166 Grafelfing.

*) protected mark of VDI Düsseldorf



DIN CERTCO Gesellschaft für
Konformitätsbewertung mbH
Alboinstraße 56, 12103 Berlin

2013-01-30
Dipl.-Ing. Peter Suxdorf
- Managing Director -





DIN CERTCO
Gesellschaft für Konformitätsbewertung mbH

CERTIFICATE

The company
UPONOR GmbH
Industriestraße 56
97437 Hassfurt
GERMANY

with the production site in
Ochtrup

hereby receives the confirmation that the product/s

Industrial installation insulation material
Uponor Thermo Twin
conforms to

VDI 2055:1994-07
and to the corresponding leaflets of VDI-AG "Gütesicherung" and
to the technical data and the details of the data sheet
Thermo-Twin (Edition: 09/2011)
and is granted the licence to use the mark *)

überwacht
nach
VDI 2055
Überwachungsstelle
FIW
FORSCHUNGSINSTITUT FÜR
WÄRMESCHUTZ E.V. MÜNCHEN

in conjunction with the Registration No. below.

Registration No.: 6V047

This Certificate is valid until 2015-03-31.

The test for conformity was conducted by

FIW Forschungsinstitut für
Wärmeschutz e.V. München
Lochhamer Schlag 4
82166 Grafelfing.

*) protected mark of VDI Düsseldorf



DIN CERTCO Gesellschaft für
Konformitätsbewertung mbH
Alboinstraße 56, 12103 Berlin

2013-01-30
Dipl.-Ing. Peter Suxdorf
- Managing Director -





Pipe and Fitting Selector Tool

Stage 1

Pick your application pipe and length...

	Order Code	Description
	Thermo Single	
	1018109	25/140
	1018110	32/140
	1018111	40/175
	1018112	50/175
	1018113	63/175
	1018114	75/200
1018115	90/200	
1018116	110/200	

	Order Code	Description
	Thermo Twin	
	1018134	2x25/175
	1018135	2x32/175
	1018136	2x40/175
	1018137	2x50/200
1018138	2x63/200	

	Order Code	Description
	Thermo Mini	
	1018132	25/68
1018133	32/68	

	Order Code	Description
	Aqua Single	
	1018117	25/140
	1018118	32/140
	1018119	40/175
	1018120	50/175
1018121	63/175	

	Order Code	Description
	Aqua Twin	
	1018139	25+25/175
	1018140	32+25/175
	1018141	40+25/175
	1018142	50+25/175

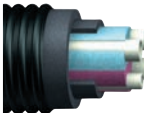
	Order Code	Description
	Quattro	
	Thermo Aqua	
	1018147	2x25/25+25/175
	1018148	2x32/25+25/175
1018149	2x32/32+25/175	

	Order Code	Description
	Supra	
	1018124	25/68
	1018125	32/68
	1018126	40/140
	1018127	50/140
	1018128	63/140
	1018129	75/175
	1018130	90/175
1018131	110/200	

Stage 2

Pick your End cap, one for each end...

	Order Code	Description
	Rubber end-cap	
	1018315	25+32/140
	1018315	25+32/140
	1018313	32+40+50/175
	1018313	32+40+50/175
	1018312	63+75/175
	1018310	75+90+110/200
	1018310	75+90+110/200
	1018310	75+90+110/200
	1018310	75+90+110/200

	Order Code	Description
	Rubber end-cap	
	1018309	2x 25+32+40/175
	1018309	2x 25+32+40/175
	1018309	2x 25+32+40/175
	1018307	2x 40+50+63/200
1018307	2x 40+50+63/200	

	Order Code	Description
	Rubber end-cap	
	1018316	25+32/68
1018316	25+32/68	

	Order Code	Description
	Rubber end-cap	
	1018315	25+32/140
	1018315	25+32/140
	1018313	32+40+50/175
	1018313	32+40+50/175
	1018312	63+75/175

	Order Code	Description
	Rubber end-cap	
	1018309	2x 25+32+40/175
	1018309	2x 25+32+40/175
	1018309	2x 25+32+40/175
	1018308	2x 25+32+50/175
1018308	2x 25+32+50/175	

	Order Code	Description
	Rubber end-cap	
	1018306	175 Quattro
	1018306	175 Quattro
1018306	175 Quattro	

	Order Code	Description
	Rubber end-cap	
	1018316	25+32/68
	1018316	25+32/68
	1018314	40+50+63/140
	1018314	40+50+63/140
	1018314	40+50+63/140
	1018312	63+75/175
	1018311	90+110/175
	1018310	75+90+110/200
	1018310	75+90+110/200
	1018310	75+90+110/200

Stage 3

Pick your coupler...

	Order Code	Description
	WIPEX Coupling, 6 bar / 95°C	
	1018328	25x1" 6B
	1018329	32x1" 6B
	1018330	40x1¼" 6B
	1018331	50x1¼" 6B
	1018332	63x2" 6B
	1018333	75x2" 6B
	1018334	90x3" 6B
1018335	110x3" 6B	

	Order Code	Description
	WIPEX Coupling, 6 bar / 95°C	
	1018328	25x1" 6B
	1018329	32x1" 6B
	1018330	40x1¼" 6B
	1018331	50x1¼" 6B
1018332	63x2" 6B	

	Order Code	Description
	WIPEX Coupling, 6 bar / 95°C	
	1018328	25x1" 6B
1018329	32x1" 6B	

	Order Code	Description
	WIPEX Coupling, 10 bar / 95°C	
	1018336	25x1" 10B
	1018338	32x1" 10B
	1018339	40x1¼" 10B
	1018340	50x1¼" 10B
1018341	63x2" 10B	

	Order Code	Description
	WIPEX Coupling, 10 bar / 95°C	
	1018336	25x1" 10B
	1018338	32x1" 10B
	1018336	25x1" 10B
	1018339	40x1¼" 10B
1018336	25x1" 10B	
1018340	50x1¼" 10B	
1018336	25x1" 10B	

	Order Code	Description
	WIPEX Coupling, 10 bar / 95°C	
	1018328	25x1" 6B
	1018336	25x1" 10B
	1018329	32x1" 6B
	1018336	25x1" 10B
	1018329	32x1" 6B
1018338	32x1" 10B	
1018336	25x1" 10B	

	Order Code	Description
	Plascon coupling	
	1018400	25x¾"
	1018401	32x1"
	1018402	40x1¼"
	1018403	50x1½"
	1018404	63x2"
	1018405	75x2½"
	1018406	90x3"
1018407	110x4"	

The Uponor Delivery Programme for Flexible & Pre-insulated pipes

Uponor Thermo Single

pre-insulated single pipe PE-X, max. 6 bar / 95°C, Heating

Order Code	Medium pipe da / di / s [mm]	DN	Jacket pipe Da [mm]	Weight [kg/m]	Delivery length max. [m]	Bending radius [m]
1018109	25 / 20.4 / 2.3	20	140	1.18	200	0.25
1018110	32 / 26.2 / 2.9	25	140	1.31	200	0.30
1018111	40 / 32.6 / 3.7	32	175	2.03	200	0.35
1018112	50 / 40.8 / 4.6	40	175	2.26	200	0.45
1018113	63 / 51.4 / 5.8	50	175	2.56	200	0.55
1018114	75 / 61.4 / 6.8	65	200	3.74	100	0.80
1018115	90 / 73.6 / 8.2	80	200	4.20	100	1.10
1018116	110 / 90.0 / 10.0	100	200	5.24	100	1.20

On request, available with heating tape HWAT-R. Delivery time on request.

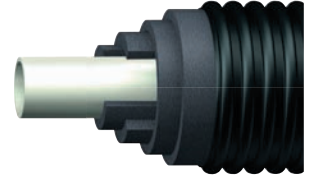

Uponor Thermo Twin

pre-insulated double pipe PE-X, max. 6 bar / 95°C, Heating

Order Code	Medium pipe da / di / s [mm]	DN	Jacket pipe Da [mm]	Weight [kg/m]	Delivery length max. [m]	Bending radius [m]
1018134	25 / 20.4 / 2.3 (2x)	20	175	1.92	200	0.50
1018135	32 / 26.2 / 2.9 (2x)	25	175	1.99	200	0.60
1018136	40 / 32.6 / 3.7 (2x)	32	175	2.33	200	0.80
1018137	50 / 40.8 / 4.6 (2x)	40	200	3.59	100	1.00
1018138	63 / 51.4 / 5.8 (2x)	50	200	4.55	100	1.20

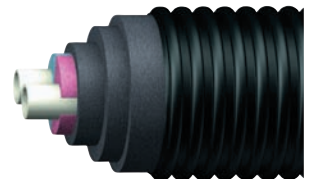

Uponor Thermo Mini

pre-insulated single pipe PE-X, max. 6 bar / 95°C, Heating

Order Code	Medium pipe da / di / s [mm]	DN	Jacket pipe Da [mm]	Weight [kg/m]	Delivery length max. [m]	Bending radius [m]
1018132	25 / 20.4 / 2.3	20	68	0.50	200	0.20
1018133	32 / 26.2 / 2.9	25	68	0.55	200	0.25



Uponor Aqua Single

pre-insulated single pipe PE-X, max. 10 bar / 95°C, warm water

Order Code	Medium pipe da / di / s [mm]	DN	Jacket pipe Da [mm]	Weight [kg/m]	Delivery length max. [m]	Bending radius [m]
1018117	25 / 18.0 / 3.5	20	140	1.24	200	0.35
1018118	32 / 23.2 / 4.4	25	140	1.42	200	0.40
1018119	40 / 29.0 / 5.5	32	175	2.20	200	0.45
1018120	50 / 36.2 / 6.9	40	175	2.54	200	0.55
1018121	63 / 45.8 / 8.7	50	175	3.00	200	0.65
1018122	75 / 54.4 / 10.3	65	200	4.3	100	0.9
1018123	90 / 65.4 / 12.3	80	200	5.3	100	1.2
1036036	110 / 79.8 / 15.1	100	200	6.5	100	1.3

On request, available with heating tape HWAT-R. Delivery time on request.

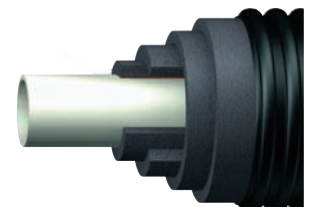

Deliveries are made in accordance with our "General Terms and Conditions of Sale". Subject to technical changes without notice.

Uponor Aqua Twin

pre-insulated double pipe PE-X, max. 10 bar / 95°C, warm water

Order Code	Medium pipe da / di / s [mm]	DN	Jacket pipe Da [mm]	Weight [kg/m]	Delivery length max. [m]	Bending radius [m]
1018139	1) 25 / 18.0 / 3.5	20	175	2.05	200	0.65
	2) 25 / 18.0 / 3.5	20				
1018140	1) 32 / 23.2 / 4.4	25	175	2.20	200	0.70
	2) 25 / 18.0 / 3.5	20				
1018141	1) 40 / 29.0 / 5.5	32	175	2.45	200	0.90
	2) 25 / 18.0 / 3.5	20				
1018142	1) 50 / 36.2 / 6.9	40	175	2.73	200	1.00
	2) 25 / 18.0 / 3.5	20				

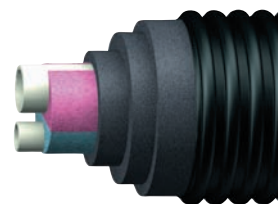

Uponor Quattro

pre-insulated quad-pipe PE-X, max. 6 bar / 95°C, Heating and/or max. 10 bar / 95°C / warm water

Order Code	Medium pipe da / di / s [mm]	DN	Jacket pipe Da [mm]	Weight [kg/m]	Delivery length max. [m]	Bending radius [m]
1018147	(2x) 25 / 20.4 / 2.3	20	175	2.41	200	0.80
	(2x) 25 / 18.0 / 3.5	20				
1018148	(2x) 32 / 26.2 / 2.9	25	175	2.64	200	0.80
	(2x) 25 / 18.0 / 3.5	20				
1018149	(2x) 32 / 26.2 / 2.9	25	175	2.78	200	0.80
	32 / 23.2 / 4.4	25				
	25 / 18.0 / 3.5	20				

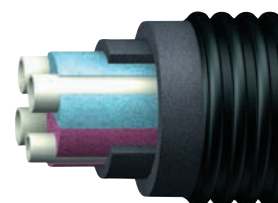

Uponor Supra

pre-insulated single pipe PE-HD, max. 16 bar / 20°C, cold water

Order Code	Medium pipe da / di / s [mm]	DN	Jacket pipe Da [mm]	Weight [kg/m]	Delivery length max. [m]	Bending radius [m]
1018124	25 / 20.4 / 2.3	20	68	0.52	200	0.20
1018125	32 / 26.2 / 2.9	25	68	0.62	200	0.25
1018126	40 / 32.6 / 3.7	32	140	1.47	200	0.30
1018127	50 / 40.8 / 4.6	40	140	1.67	200	0.40
1018128	63 / 51.4 / 5.8	50	140	1.97	200	0.50
1018129	75 / 61.4 / 6.8	65	175	2.72	100	0.60
1018130	90 / 73.6 / 8.2	80	175	3.14	100	0.70
1018131	110 / 90.0 / 10.0	100	200	5.24	100	1.20

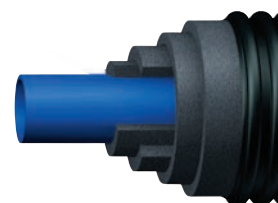

Uponor Supra Plus

fitted with self-regulating, freeze protection cable, rated at 10 w/m.

Order Code	Medium pipe da / di / s [mm]	n	Jacket pipe Da [mm]	Weight [kg/m]	Delivery lengths [m]	Bending radius [m]	Insulation thickness [mm]
1048902	25 / 20.4 / 2.3	1	68	0.52	150	0.20	15
1048903	32 / 26.2 / 2.9	1	68	0.62	150	0.25	12
1048904	40 / 32.6 / 3.7	3	140	1.44	150	0.30	39
1048905	50 / 40.8 / 4.6	3	140	1.67	150	0.40	34
1048906	63 / 51.4 / 5.8	2	140	1.97	150	0.50	27
1048907	75 / 61.4 / 6.8	3	175	2.89	100	0.60	38
1048908	90 / 73.6 / 8.2	2	175	3.31	100	0.70	28
1048909	110 / 90.0 / 10.0	3	200	5.24	100	1.20	30



Uponor Wipex male connector 6 bar

6 bar / 95°C for Uponor pipe systems Thermo Single, Thermo Twin, Thermo Mini, Quattro

Order Code	Pipe size da / di / s [mm]	Connection Male thread [inch]	Weight [kg/piece]	l [mm]	l ₁ [mm]
1018328	25 / 20.4 / 2.3	1"	0.20	26	13
1018329	32 / 26.2 / 2.9	1"	0.30	38	13
1018330	40 / 32.6 / 3.7	1 1/4"	0.50	44	14
1018331	50 / 40.8 / 4.6	1 1/4"	0.70	51	14
1018332	63 / 51.4 / 5.8	2"	1.20	67	16
1018333	75 / 61.4 / 6.8	2"	1.50	71	17
1018334	90 / 73.6 / 8.2	3"	2.40	80	17
1018335	110 / 90.0 / 10.0	3"	3.50	92	17

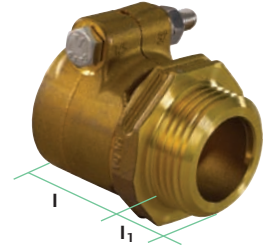

Uponor Wipex male connector 10 bar

for Uponor pipe systems Aqua Single, Aqua Twin, Quattro (DVGW-approved)

Order Code	Pipe size da / di / s [mm]	Connection Male thread [inch]	Weight [kg/piece]	l [mm]	l ₁ [mm]
1018336	25 / 18.0 / 3.5	1"	0.20	26	13
1018338	32 / 23.2 / 4.4	1"	0.30	38	13
1018339	40 / 29.0 / 5.5	1 1/4"	0.50	44	14
1018340	50 / 36.4 / 6.8	1 1/4"	0.70	51	14
1018341	63 / 45.8 / 8.7	2"	1.20	67	16
1018342	75 / 54.4 / 10.3	2"	1.55	71	17
1018343	90 / 65.4 / 12.3	3"	2.40	80	17
1023170	110 / 79.8 / 15.1	3"	3.50	92	17

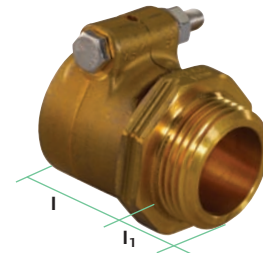

Uponor Wipex Jointing Equal 6 bar

for Uponor pipe systems Thermo Single, Thermo Twin, Thermo Mini, Quattro

Order Code	Pipe size	For Pipe dim [mm]	Weight [kg]
1042972	25 PN6	25 x 2,3	0,168
1042973	32 PN6	32 x 2,9	0,358
1042980	40 PN6	40 x 3,7	0,554
1042984	50 PN6	50 x 4,6	0,984
1042981	63 PN6	63 x 5,8	1,575
1042985	75 PN6	75 x 6,8	2,405
1042986	90 PN6	90 x 8,2	3,622
1042987	110 PN6	110 x 10	5,127



Uponor Wipex Jointing Equal 10 bar

for Uponor pipe systems Aqua Single, Aqua Twin, Quattro

Order Code	Pipe size	For Pipe dim [mm]	Weight [kg]
1042970	25 PN10	25 x 3,5	0,179
1042974	32 PN10	32 x 4,4	0,345
1042979	40 PN10	40 x 5,5	0,551
1042983	50 PN10	50 x 6,9	0,974
1042982	63 PN10	63 x 8,7	1,582



Uponor Wipex T-piece

for Uponor pipe systems Aqua Single, Aqua Twin, Thermo Single, Thermo Twin, Thermo Mini, Quattro

Order Code	Dimensions O-Ring di x s [mm]	Connection Male thread [inch]	Weight		z [mm]
			[kg/piece]		
1018345	35.0 x 3.0	1"	0.31		35
1018346	43.5 x 3.0	1 1/4"	0.48		42
1018347	61.91 x 3.53	2"	1.01		55
1018348	90.0 x 4.0	3"	2.64		75

incl. O-Rings

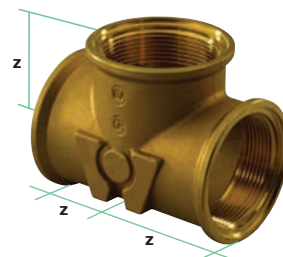

Uponor Wipex elbow

for Uponor pipe systems Aqua Single, Aqua Twin, Thermo Single, Thermo Twin, Thermo Mini, Quattro

Order Code	Dimensions O-Ring di x s [mm]	Connection Female thread [inch]	Weight		z [mm]
			[kg/piece]	l [mm]	
1018350	35.0 x 3.0	1"	0.27	58	35
1018351	43.5 x 3.0	1 1/4"	0.45	68	42
1018352	61.91 x 3.53	2"	0.94	91	55
1018353	90.0 x 4.0	3"	2.20	126	75

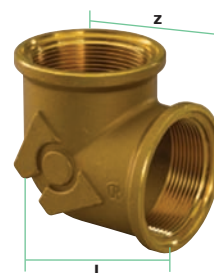

Uponor Wipex joint

for Uponor pipe systems Aqua Single, Aqua Twin, Thermo Single, Thermo Twin, Thermo Mini, Quattro

Order Code	Dimensions O-Ring da x s [mm]	Connection female thread [inch]	Weight		z [mm]
			[kg/piece]		
1018355	35.0 x 3.0	1"	0,18		30
1018356	43.5 x 3.0	1 1/4"	0,20		37
1018357	61.91 x 3.53	2"	0,39		45
1018358	90.0 x 4.0	3"	0,70		55

incl. O-Rings

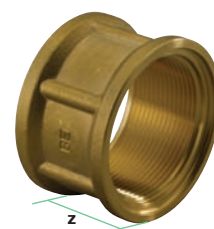

Uponor Wipex reducer

for Uponor pipe systems Aqua Single, Aqua Twin, Thermo Single, Thermo Twin, Thermo Mini, Quattro

Order Code	Dimensions O-Ring di x s [mm]	R 1	R 2	Weight	
		male thread [inch]	female thread [inch]	[kg/piece]	z [mm]
1018368	35.0 x 3.0	1 1/4"	1"	0.22	20
1018369	43.5 x 3.0	1 1/2"	1 1/4"	0.25	21
1018371	35.0 x 3.0	2"	1"	0.41	21
1018372	43.5 x 3.0	2"	1 1/4"	0.46	25
1018374	35.0 x 3.0	3"	1"	0.92	23
1018375	43.5 x 3.0	3"	1 1/4"	1.03	27
1018376	61.91 x 3.53	3"	2"	0.99	31

incl. O-Rings

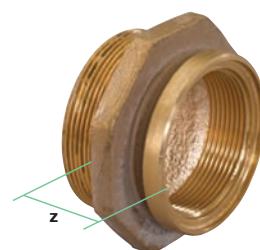

Uponor Wipex flange

for Uponor pipe systems Aqua Single, Aqua Twin, Thermo Single, Thermo Twin, Thermo Mini, Quattro

Order Code	DN	Screw holes Number	Dimensions O-Ring di x s [mm]	Connection female thread [inch]	Weight [kg/piece]	k [mm]	ds [mm]	d [mm]
1018359	25	4	35.0 x 3.0	1"	1.33	85	14	115
1018360	32	4	43.5 x 3.0	1 1/4"	1.96	100	18	140
1018362	50	4	61.91 x 3.53	2"	2.96	125	18	165
1018364	80	8	90.0 x 4.0	3"	4.36	160	18	200

incl. O-Rings

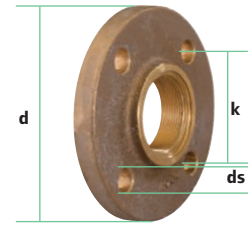

Uponor Wipex double union

For connecting wipex bodies together when installed in a chamber or H insulation set.

Order Code	DN	R 1 male thread [inch]	R 2 male thread [inch]	Weight [kg/piece]	z [mm]
1018322	25	1"	1"	0.126	6
1018323	32	1 1/4"	1 1/4"	0.226	7
1018324	50	2"	2"	0.432	8
1018325	80	3"	3"	0.918	10

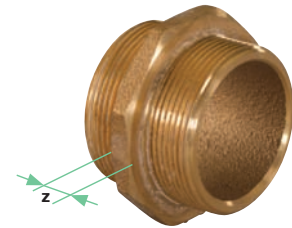

Uponor plastic male connector

for main service take-off on Uponor Supra pipes

Order Code	For medium pipe dimensions da/s [mm]	Male thread [inch]	Weight [kg]	l [mm]
1018400	25 x 2.3	3/4"	0.073	95
1018401	32 x 2.9	1"	0.115	106
1018402	40 x 3.7	1 1/4"	0.192	116
1018403	50 x 4.6	1 1/2"	0.282	135
1014804	63 x 5.8	2"	0.480	167
1018405	75 x 6.8	2 1/2"	0.728	191
1018406	90 x 8.2	3"	1.133	230
1018407	110 x 10.0	4"	1.919	267

Material: Polypropylene high-grade copolymer

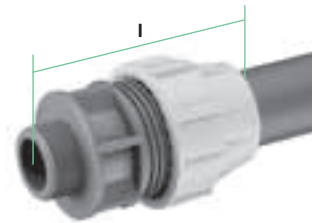

Uponor rubber end-cap

incl. clamping ring and swelling ring

Order Code	For medium pipe da [mm]	For jacket pipe Da [mm]	Weight [kg/piece]	Use with product	l [mm]	l ₁ [mm]
1018316	25+32	68	0.15	Thermo Mini, Supra	80	140
1018315	25+28+32	140	0.29	Thermo Single/Aqua Single	90	184
1018313	32+40+50	175	0.39	Thermo Single/Aqua Single	90	184
1018314	40+50+63	140	0.30	Supra	90	184
1018312	63+75	175	0.41	Thermo Single/Aqua Single/Supra	90	184
1018310	75+90+110	200	0.45	Thermo Single/Supra	90	184
1018311	90+110	175	0.43	Supra	90	184
1018309	2x25+32+40	175	0.41	Thermo Twin/Aqua Twin	90	184
1018308	2x25+32+50	175	0.41	Thermo Twin/Aqua Twin	90	184
1018307	2x40+50+63	200	0.49	Thermo Twin	90	184
1018306	2x25+32 25+28+32 22+25+32	175	0.45	Quattro	90	184

Material: EPDM, clamping ring: stainless steel

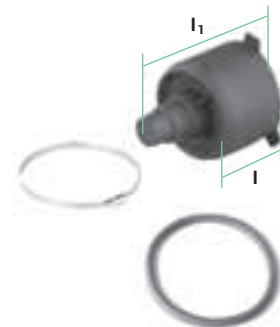

Uponor T-insulation set

Old Code	Order Code	Jacket pipe diameter [mm]	Length l [mm]	Width b [mm]	Weight [kg/set]
1021990	1060982	140/175/200	1125	788	13.53

Comprises insulating half-shells (ABS lined with PUR foam), stainless steel bolts and solvent-free sealant.



Uponor straight insulation set

Old Code	Order Code	Jacket pipe diameter [mm]	Length l [mm]	Width b [mm]	Weight [kg/set]
1021992	1060984	140/175/200	1200	270	9.66

Comprises insulating half-shells (ABS lined with PUR foam), stainless steel bolts and solvent-free sealant.

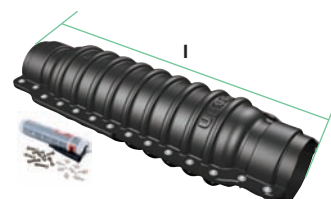

Uponor H-insulation set

Old Code	Order Code	Jacket pipe diameter [mm]	Length l [mm]	Width b [mm]	Weight [kg/set]
-	1007355	140/175/200	1290	1260	19.00

Comprises insulating half-shells (ABS lined with PEX foam), stainless steel bolts, plastic rivets and solvent-free sealant.

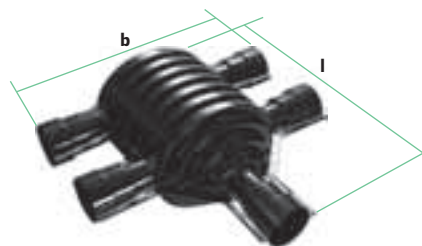

Uponor elbow insulation set

Old Code	Order Code	Jacket pipe diameter [mm]	Length l [mm]	Width b [mm]	Weight [kg/set]
1021991	1060985	200 / 175 / 140	805	805	10.55

Comprises insulating half-shells (ABS lined with PUR foam), stainless steel bolts and solvent-free sealant.

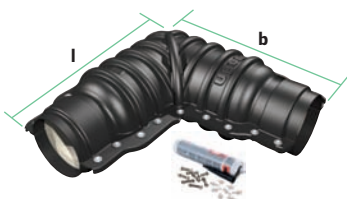

Uponor reducer rings

used with 25mm and 32mm Thermo Mini and Supra pipes when connecting into insulation sets.

Order Code	Diameter
1060991	200/68



Uponor chamber

Order Code	Diameter outer d [mm]	Number connections x jacket pipe diameter [mm]	Height h [mm]	Length l [mm]	Weight [kg/piece]
1018326	980	6 x 140 / 175 / 200 685	1660	50	
1018327	980	8 x 140 / 175 / 200 685	1660	52	

Material: chamber PE + PE-foam, cover: PE, sealing ring: SBR, screws: stainless steel

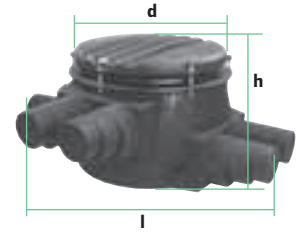

Uponor heat-shrinkable tube

for chamber

Order Code	Jacket pipe Diameter [mm]	l [m]	Weight [kg/piece]
1018380	175	0.25	0.25
1018381	200	0.30	0.30

Material: PEX

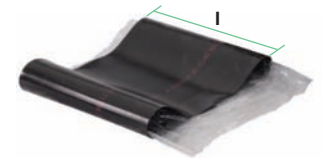

Uponor sealing tape for heat-shrinkable tube

for sealing jacket pipe inlet in the Uponor chamber

Order Code	l [m]
1018382	10



Uponor wall sleeve NPW (non-pressure water-proof)

with heat-shrinkable tube, non pressure water-proof

Order Code	Jacket pipe diameter [mm]	Diameter wall sleeve da [mm]	l [mm]	Weight [kg/piece]
1018266	68	90	375	0.80
1018269	140	175	375	1.0
1018268	200/175	250	375	2.10

Material: wall sleeve PE-HD, heat-shrinkable tube: PEX

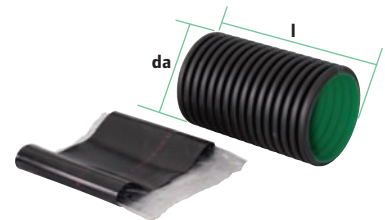

Uponor wall seal PWP (pressure water-proof)

pressure water-proof. For direct use in a water-proof concrete core hole or in a walled-in fibre cement pipe

Order Code	Jacket pipe diameter [mm]	Core hole diameter [mm]	l [mm]	Weight [kg/piece]
1007358	68	125	110	1.21
1007360	140	200	110	2.42
1007361	175	250	110	3.70
1007362	200	300	110	4.90

Material: rubber ring: EPDM, screws: yellow chromated, metal core: yellow chromated

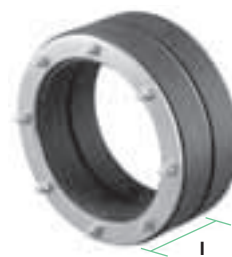

Uponor fibre cement pipe PWP (pressure water-proof)

for wall seal, pressure water-proof

Order Code	Liner pipe diameter DN	For jacket pipe diameter [mm]	l [mm]	Weight [kg/piece]
1007368	125	68	400	8.00
1007370	200	140	400	15.20
1007371	250	175	400	18.80
1007372	300	200	400	22.00

Material: Fibre cement

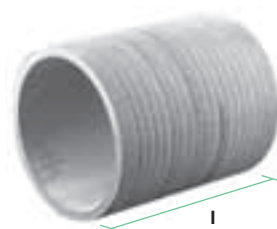

Uponor supplementary set PWP (pressure water-proof)

for wall seals, PWP, to reduce any tension of the jacket pipe when it is not perpendicular to the wall

Order Code	Jacket pipe diameter [mm]	Core hole diameter [mm]	l [mm]	Weight [kg/piece]
1007363	68	125	65	0.72
1007365	140	200	65	1.43
1007366	175	250	65	2.30
1007367	200	300	65	3.30

Material: rubber ring: EPDM, screws: yellow chromated



Uponor Supra Plus Connection Set

set includes Supra Plus Control Unit, 2 rubber end caps, 5m sensor cable, fixing screws, cable connections and full instructions. Control unit requires 230V supply.

Order Code	For medium pipe diameter [mm]	Jacket pipe diameter [mm]	Weight [kg/set]
1048697	25+32	68	1
1048699	40+50+63	140	1.08
1048700	75	175	1.53
1048701	90	175	1.64
1048702	110	200	1.92



Uponor End Cover

for use in dry areas in buildings where the pipe exits the floor. Non waterproof. Set comprises two plastic half-shells and foam inserts for single, twin and quattro pipes.

Order Code	Jacket pipe diameter [mm]	Weight [kg/piece]
1045310	140	0.1
1045311	175	0.14
1045312	200	0.18



Uponor Trench Warning Tape

to mark position of buried pipes. Red, tear-proof plastic tape imprinted with "Uponor" and symbols for trench identification.

Order Code	L [m]	W [mm]	Weight [kg/piece]
1018385	250	40	2



Uponor Shrinkable Tape

shrinkable tape used for sealing damaged outer jacket.

Order Code	L [m]	W [mm]	Weight [kg/piece]
1018378	30	255	0.49

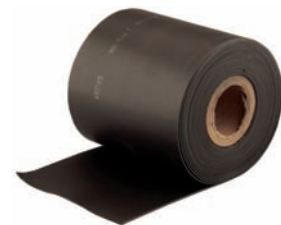

Uponor Limited ("Uponor") guarantees [to the original purchaser/customer] that pipes and fittings sold by it are free of defects in materials or manufacture under normal conditions of use for a period of 25 years and in case of electrical and mechanical products for 2 years from the date of installation. This guarantee only applies to the products stored, installed, tested and operated in accordance with the fitting instructions issued by Uponor and valid at the time the products were installed.

Where a claim is made during the guarantee period and products are proven to be defective in materials and/or manufacture at the time of delivery, Uponor will supply replacement products free of charge. This is the exclusive remedy under this guarantee.

Uponor disclaims any warranty or guarantee not expressly provided for herein, including any implied warranties of merchantability or fitness for a particular purpose. Uponor further disclaims any and all responsibility or liability for losses, damages and expenses, including special, direct, indirect, incidental and consequential damages, whether foreseeable or not, including without limitation any loss of time or use or any inconvenience arising from the ownership, installation or use of the products sold hereunder.

This guarantee does not affect the statutory rights of the consumer.

Copyright © Uponor (Uponor Limited.)

Reproduction of any part of this publication for any purpose is not permitted without the prior written permission of Uponor Limited.

The contents of this brochure are provided for guideline only, please consult our technical manuals for full up-to-date information.

Uponor reserves the right to alter specifications and operating parameters for all their Underfloor Heating and Plumbing & Heating Systems at any time as part of its policy of continuous product development.

Care has been taken to ensure that the information in this price guide is correct at the time of going to press. Uponor Limited reserve the right to alter prices and the details of designs and performance of products without notice. E&OE.



Uponor Limited

Head Office
Gilmorton Road
Lutterworth
Leicestershire
LE17 4DU

T 01455 550355
F 01455 550366
E enquiries.uk@uponor.com
W www.uponor.co.uk